



**M&P**<sup>®</sup>

by **Smith & Wesson**<sup>®</sup>

---

**Safety & Instruction Manual**  
**M&P<sup>®</sup> M2.0<sup>™</sup> PISTOLS**

---



**M&P**<sup>®</sup> M2.0<sup>™</sup>



**Performance Center**<sup>®</sup>  
**Models Included**

The original M&P<sup>®</sup> Pistols are covered in a separate manual (#441300000). Available Free Upon Request.



**Read the instructions and  
warnings in this manual  
CAREFULLY BEFORE  
using this firearm.**

**2100 Roosevelt Avenue • Springfield, MA 01104**  
**1-800-331-0852 • Fax: 413-747-3317**  
**[www.smith-wesson.com](http://www.smith-wesson.com)**

Copyright © 2021 Smith & Wesson Inc.  
All rights reserved.



## **WARNING:**



**READ THESE INSTRUCTIONS  
AND WARNINGS CAREFULLY. BE SURE  
YOU UNDERSTAND THESE INSTRUCTIONS  
AND WARNINGS BEFORE USING  
THIS FIREARM. FAILURE TO READ THESE  
INSTRUCTIONS AND TO FOLLOW THESE  
WARNINGS MAY RESULT IN SERIOUS INJURY  
OR DEATH TO YOU AND OTHERS AND  
DAMAGE TO PROPERTY.**

**This SAFETY & INSTRUCTION MANUAL  
should always accompany  
this firearm and be transferred  
with it upon change of ownership  
or when presented to another person.**

**A copy of the  
SAFETY & INSTRUCTION MANUAL  
is available FREE  
via download at  
[www.smith-wesson.com](http://www.smith-wesson.com)  
or upon request from:**

**SMITH & WESSON®  
CUSTOMER SUPPORT CENTER  
2100 ROOSEVELT AVENUE  
SPRINGFIELD, MA 01104**

**TEL.: 1-800-331-0852, ext. 4125  
E-mail: [qa@smith-wesson.com](mailto:qa@smith-wesson.com)**

## TABLE OF CONTENTS

YOUR SAFETY RESPONSIBILITIES .....	3-6
SAFE STORAGE AND TRANSPORTATION.....	7-8
AMMUNITION.....	9-11
MODEL AND FEATURES IDENTIFICATION .....	12
INSPECTING YOUR PISTOL .....	13-14
MANUAL THUMB SAFETY - (If pistol is so-equipped).....	15
LOADED CHAMBER INDICATOR .....	16
PREPARATION FOR FIRING .....	17-18
LOADING.....	18-20
FIRING .....	20-21
HANGFIRES AND MISFIRES .....	22-23
CLEARING A MISFEED/JAM .....	24
UNLOADING .....	25
FIELD STRIPPING / DISASSEMBLY .....	26-28
LUBRICATION .....	29
ASSEMBLY .....	29-31
INTERCHANGEABLE PALMSWELL GRIP INSERTS .....	32
REVERSIBLE MAGAZINE RELEASE .....	33-34
MAGAZINE .....	34-35
SIGHT ADJUSTMENT .....	35
CLEANING AND MAINTENANCE .....	36-38
LIMITED WARRANTY .....	38-39
CONTACT AND SHIPPING INFORMATION.....	40-41
CORE OPTICAL SIGHT ADAPTER - (If pistol is so-equipped).....	42-45
OVERTRAVEL ADJUSTMENT SCREW - (If pistol is so-equipped) .....	46-49
PORTED BARREL WARNINGS - (If pistol is so-equipped) .....	49
BATTERY WARNINGS AND PATENT INFORMATION.....	50
CUSTOM SERVICE AND INTERNATIONAL WARRANTY CENTERS.....	52

## YOUR SAFETY RESPONSIBILITIES

### SAFETY IS YOUR NUMBER ONE RESPONSIBILITY!

- At home, in the field, at the range, or anywhere, the first concern of every firearm owner should be safety. Apply the following safety rules in every situation, with any kind of firearm. If you feel uncertain about any operational aspects of your firearm, please contact Smith & Wesson® at 1-800-331-0852, ext. 4125 before proceeding with its operation.
- If you are unfamiliar with firearms you should seek formal training before using your pistol.



**WARNING: YOU MUST FOLLOW ALL OF THESE SAFETY RULES TO ENSURE THE SAFE USE OF YOUR FIREARM. THE FAILURE TO FOLLOW THE INSTRUCTIONS AND WARNINGS IN THIS MANUAL COULD CAUSE SERIOUS PERSONAL INJURY OR DEATH TO YOU OR OTHERS AND DAMAGE TO PROPERTY.**

- As a firearm owner, you accept a demanding responsibility. How seriously you take this responsibility can be the difference between life and death. There is no excuse for careless or abusive handling of your firearm. At all times handle your firearm with intense respect for its power and potential danger.

## YOUR SAFETY RESPONSIBILITIES CONTINUED

- **ALWAYS KEEP YOUR FIREARM POINTED IN A SAFE DIRECTION.** Never point a firearm at anyone or anything you do not intend to shoot whether or not it is loaded. This is particularly important when loading, unloading, or field stripping the gun. ALWAYS control the direction of the firearm.
- **ALWAYS TREAT EVERY FIREARM AS IF IT IS LOADED AND WILL FIRE.** Do not take anyone's word that the firearm is unloaded – always check for yourself. Never pass your firearm to another person until the cylinder or action is open and you visually check that it is unloaded. Keep your firearm unloaded and safely stored when not in use.
- **NEVER PLACE YOUR FINGER INSIDE THE TRIGGER GUARD OR ON THE TRIGGER UNLESS YOU INTEND TO FIRE.** Ensure that other objects do not touch the trigger.
- **ALWAYS BE SURE OF YOUR TARGET AND WHAT IS BEYOND IT.** Always be sure of where the bullet will strike and shoot only where there is a safe backstop free of obstructions, water or other surfaces which can cause ricochets. Be sure your bullet will stop behind your target. Bullets can glance off many surfaces like rocks or the surface of water and travel in unpredictable directions with considerable velocity. Do not fire randomly into the sky.
- **NEVER CROSS OBSTACLES SUCH AS FENCES OR STREAMS WITH A LOADED FIREARM.** Always make certain your firearm is unloaded before crossing a fence, climbing a tree, jumping a ditch or negotiating other obstacles.
- **SAFE GUN HANDLING IS YOUR PERSONAL RESPONSIBILITY AT ALL TIMES.** Firearms are dangerous and can cause serious injury or death if they are misused or used inappropriately. Safety must be the prime consideration of any one who owns or handles firearms. Accidents are the result of violating the rules of safe gun handling and common sense. Firearm safety training is available. Contact your firearms dealer, law enforcement agency, local sportsman's club, etc. for availability.
- **YOU ARE RESPONSIBLE FOR THE FIREARM AT ALL TIMES.** In owning a firearm, you must undertake full-time responsibility for your firearm's safety and security. You must protect yourself and all others against injury or death from misuse of the firearm 24 hours a day.
- **FIREARM SECURITY IS YOUR RESPONSIBILITY.** You must secure firearms safely from children and/or unauthorized users. Your firearm should always be kept unloaded and locked when not in use. A lock has been provided for this purpose. Never assume that the use of this lock is sufficient to safely secure your firearm. You must always evaluate your personal situation and employ the security systems that meet your needs and prevent children and unauthorized users from gaining access to your firearm.



---

## YOUR SAFETY RESPONSIBILITIES CONTINUED

---

- **APPROPRIATE USE FOR YOUR FIREARM MEANS USING YOUR FIREARM FOR LEGAL PURPOSES.** For example - target shooting, hunting and lawful resistance of deadly criminal force. It is your responsibility to ensure that you are in compliance with all applicable laws and ordinances regarding the use of your firearm.
- **NEVER RELY ON MECHANICAL FEATURES ALONE.** Only your safe gun-handling habits will ensure the safe use of your firearm. This is your responsibility.
- **ALWAYS SAFELY STORE AND SECURE YOUR FIREARM.** Safe and secure storage of your firearm is one of your most important responsibilities. It is a full-time responsibility. You must always secure your firearm and ammunition separately so that they are not accessible to children and/or other unauthorized persons.
- **NEVER KEEP AMMUNITION IN THE SAME LOCATION AS THE FIREARM.** Store each in a separate and secure place.
- **ALWAYS WEAR EYE PROTECTION THAT IS SPECIFIED FOR USE WITH FIREARMS** every time you handle your firearm for cleaning and maintenance.
- **ALWAYS WEAR EYE AND HEARING PROTECTION THAT ARE SPECIFIED FOR USE WITH FIREARMS** every time you discharge your firearm. Make sure others in the vicinity of where you will be shooting do so as well.
- **NEVER USE ALCOHOL OR DRUGS BEFORE OR WHILE SHOOTING.** Do not use your firearm if you are on any medication which impairs, even slightly, your mental or physical ability.
- **ALWAYS HAVE ADEQUATE VENTILATION.** Discharging firearms in poorly ventilated areas, cleaning firearms, or handling ammunition may result in exposure to lead and other substances known to cause birth defects, reproductive harm, and other serious physical injury. Review the warnings and labels for all ammunition and cleaning products carefully. Wash hands thoroughly after exposure.
- **BEFORE HANDLING ANY FIREARM, UNDERSTAND ITS OPERATION.** Not all firearms are the same. Familiarize yourself with the mechanical features of any firearm you intend to use. If you feel uncertain about any operational aspects of your firearm, please contact Smith & Wesson® at 1-800-331-0852, ext. 4125 before proceeding with its operation.
- **NEVER ALLOW A FIREARM TO BE USED BY INDIVIDUALS WHO DO NOT UNDERSTAND ITS SAFE OPERATION OR HAVE NOT READ THESE FIREARM SAFETY RULES.**

## YOUR SAFETY RESPONSIBILITIES CONTINUED

- **ALWAYS USE THE CORRECT AMMUNITION FOR YOUR PARTICULAR FIREARM** as indicated by the marking on the firearm. Never use non-standard, damaged, corroded or reloaded, (handloaded) ammunition which has not been subjected to internal ballistic pressure testing.
- **BEWARE OF BARREL OBSTRUCTIONS.** Be sure the barrel is clear of obstructions before shooting. Mud, water, snow or other objects may inadvertently lodge in the barrel bore. A small obstruction can cause a dangerous increase in pressure and may damage your gun and cause injury to yourself and others.
- **BE SURE ALL ACCESSORIES, SUCH AS HOLSTERS, GRIPS, SLINGS, SCOPES AND OTHER ACCESSORIES ARE COMPATIBLE** with the firearm and that the accessories do not interfere with safe operation. It is your responsibility to understand and follow all of the instructions in this manual, as well as those which may be supplied with your ammunition and any accessory.
- **NEVER DISASSEMBLE YOUR FIREARM** beyond the field stripping procedure outlined in this manual. Improper disassembly or reassembly of your firearm may be dangerous and can lead to serious injury or death.
- **NEVER MANIPULATE, ADJUST OR CHANGE ANY OF THE INTERNAL COMPONENTS OF YOUR FIREARM UNLESS SPECIFICALLY INSTRUCTED TO DO SO IN THIS MANUAL.** Improper manipulation of any other internal component may affect the safety and reliability of your firearm and may cause serious injury or death.
- **NEVER ALLOW ANY ALTERATION OR REPLACEMENT OF PARTS IN YOUR SMITH & WESSON® FIREARM UNLESS PERFORMED BY A QUALIFIED GUNSMITH** using genuine Smith & Wesson® parts. If you do otherwise, improper functioning of your firearm may occur and serious injury or death and damage to property may result.



**WARNING: SAFE USE OF A FIREARM IS YOUR PERSONAL RESPONSIBILITY AND THE FAILURE TO FOLLOW ALL OF THESE BASIC SAFETY RULES MAY RESULT IN SEVERE PERSONAL INJURY OR DEATH TO YOU OR OTHERS AND DAMAGE TO PROPERTY. YOU ARE THE MOST IMPORTANT SAFETY DEVICE WHEN IT COMES TO THE USE OF YOUR FIREARM AND SMITH & WESSON WILL NOT BE RESPONSIBLE FOR ANY PERSONAL INJURY, DEATH OR PROPERTY DAMAGE THAT RESULTS FROM: (1) THE CRIMINAL OR NEGLIGENT USE OF THIS FIREARM; (2) A DISREGARD OF THESE SAFETY INSTRUCTIONS AND WARNINGS; (3) IMPROPER OR CARELESS HANDLING OF THIS FIREARM; (4) THE USE OF NON-STANDARD, DEFECTIVE OR IMPROPER AMMUNITION OR; (5) IMPROPER OR NEGLIGENT MODIFICATIONS OR REPAIRS TO THE FIREARM.**

# SAFE STORAGE AND TRANSPORTATION



**WARNING: ALWAYS POINT THE MUZZLE IN A SAFE DIRECTION.**



**WARNING: FIREARMS ARE DANGEROUS WHEN USED AND STORED IMPROPERLY. THEY POSE A RISK OF SERIOUS OR FATAL INJURIES. FIREARMS CAN BE ESPECIALLY DANGEROUS TO CHILDREN WHEN THEY ARE STORED IN AN IRRESPONSIBLE AND UNSAFE MANNER. FOR YOUR SAFETY AND THE SAFETY OF OTHERS, IT IS IMPERATIVE THAT YOU KEEP YOUR FIREARM LOCKED AND UNLOADED IN A SECURE PLACE. THE AMMUNITION SHOULD BE STORED IN A SEPARATE, SECURE LOCATION WHEN IT IS NOT IN USE. SAFE AND SECURE STORAGE OF YOUR FIREARM IS ONE OF THE MOST IMPORTANT RULES OF FIREARM SAFETY. YOUR FAILURE TO FOLLOW THESE RULES MAY RESULT IN SERIOUS INJURY OR DEATH TO YOU OR OTHERS.**

- **ALWAYS SECURE YOUR FIREARM IN A MANNER THAT WILL PREVENT UNAUTHORIZED ACCESS.** Whenever your firearm is not in use, keep it unloaded and locked. Your safety and the safety of others requires that you always secure and store your firearm in a manner that will prevent unauthorized access. Never leave a firearm unattended unless it is locked, unloaded and secured.
- **ALWAYS USE THE LOCK PROVIDED BY SMITH & WESSON® TO SECURE YOUR FIREARM.** Please read and follow the instructions packaged separately for the use of this lock. A lock, when properly used, can be an effective tool in preventing unauthorized access to your firearm. There are other alternative locks and safe storage containers available in the marketplace which may also be appropriate for your particular needs. Consult your local gun shop, hardware store, or local police department for guidance on the variety of other safe storage devices or practices which may be appropriate for your particular needs. By purchasing this firearm you have accepted the responsibility of safely securing the firearm at all times and preventing its unauthorized use. Never assume that the use of this lock alone is sufficient to safely secure your firearm. It is your personal responsibility to select and use whatever measures or practices that will enable you to be absolutely certain that your firearm is secure at all times.



**WARNING: NEVER LOCK A LOADED FIREARM AND NEVER LOAD A LOCKED FIREARM!!**

- **ALWAYS STORE YOUR FIREARM AND AMMUNITION SEPARATELY** so that they are not accessible to children or other unauthorized persons. Safe and secure storage of your firearm and ammunition are your responsibility. It is a full-time responsibility.

## SAFE STORAGE AND TRANSPORTATION CONTINUED

- **NEVER ASSUME THAT A "HIDING" PLACE IS A SECURE STORAGE METHOD.** Others may be aware of your storage location or come upon it by chance. It is your personal responsibility to use common sense when storing your firearm and ammunition and to always make sure they are not accessible to children or other unauthorized persons.
- **NEVER TRANSPORT A LOADED FIREARM.** When transporting your firearm, be sure it is unloaded and locked. Safe and secure transportation of your firearm is your responsibility.
- **ALWAYS FOLLOW THE LAW!** Many jurisdictions have laws that make it a crime to keep a firearm unlocked and in an area accessible to children or others. Keeping a firearm locked and unloaded when not in use is not only common sense safety practice... IT IS THE LAW. You must be familiar with all local, state, and federal laws regarding the safe storage and transportation of your firearm. Failure to know and follow the law may result in unauthorized access or use of your firearm by another. Obey all laws relating to the storage and transportation of firearms. Your local police department or gun shop can furnish you with available information on storing and/or transporting a firearm safely and legally.
- **YOUR FIREARM IS YOUR RESPONSIBILITY.** You must prevent your firearm from being stolen or from being used by untrained or unqualified individuals. Keep it locked, unloaded and secured when not in use.



# AMMUNITION



**WARNING: NEVER USE AMMUNITION NOT SPECIFICALLY DESIGNATED FOR USE IN YOUR FIREARM. FAILURE TO USE THE CORRECT TYPE OR CALIBER OF AMMUNITION MAY CAUSE THE FIREARM TO JAM, FAIL TO FIRE OR EVEN GENERATE EXCESSIVE PRESSURE WHICH CAN DAMAGE OR EVEN RUPTURE YOUR FIREARM, CAUSING PERSONAL INJURY, DEATH OR PROPERTY DAMAGE.**

- Locate the cartridge designation marked on the firearm. This information indicates the correct ammunition that must be used in this firearm (FIGURE 1).
- You are responsible for selecting ammunition that meets industry standards and is appropriate in type and caliber for this firearm.



- Never use a cartridge not specifically designated for use in your firearm. The wrong type of ammunition may exceed the capability of your firearm and may damage or even rupture your firearm.
- Never mix ammunition.



**WARNING: IN SOME CASES, A ROUND OF AMMUNITION NOT SPECIFIED ON YOUR FIREARM AND NOT LISTED AS ALTERNATE AMMUNITION IN THIS MANUAL, MAY FIT INTO THE CHAMBER. FIRING THIS AMMUNITION MAY CAUSE A RUPTURE RESULTING IN DAMAGE TO THE FIREARM AND PERSONAL INJURY OR DEATH TO THE SHOOTER OR BYSTANDERS. FOR MORE INFORMATION REGARDING UNSAFE CALIBER COMBINATIONS, REFER TO THE FOLLOWING URL: [HTTPS://SAAMI.ORG/TECHNICAL-INFORMATION/UNSAFE-FIREARM-AMMUNITION-COMBINATIONS/](https://saami.org/technical-information/unsafe-firearm-ammunition-combinations/)**



**WARNING: ALWAYS INSPECT YOUR AMMUNITION BEFORE USING IT. NEVER USE DIRTY, CORRODED OR DAMAGED AMMUNITION. A BORE OBSTRUCTION OR BURST CARTRIDGE MAY RESULT, CAUSING DAMAGE TO THE FIREARM AND PERSONAL INJURY OR DEATH TO THE SHOOTER OR BYSTANDERS.**



**WARNING: DISCHARGING FIREARMS IN POORLY VENTILATED AREAS, CLEANING FIREARMS, OR HANDLING AMMUNITION MAY RESULT IN EXPOSURE TO LEAD AND OTHER SUBSTANCES KNOWN TO CAUSE BIRTH DEFECTS, REPRODUCTIVE HARM, AND OTHER SERIOUS PHYSICAL INJURY. HAVE ADEQUATE VENTILATION AT ALL TIMES. WASH HANDS THOROUGHLY AFTER EXPOSURE.**

## AMMUNITION CONTINUED

- Use only commercially manufactured ammunition with internal ballistic pressures which are in strict accordance with the specifications of the Sporting Arms and Ammunition Manufacturers' Institute (SAAMI). If you are uncertain, contact your ammunition supplier for verification.



**WARNING: NEVER USE NON-STANDARD, RELOADED OR "HANDLOADED" AMMUNITION WHICH HAS NOT BEEN SUBJECTED TO INTERNAL BALLISTIC PRESSURE TESTING.**

**RELOADED OR HANDLOADED AMMUNITION, MAY HAVE MANY MANUFACTURING AND QUALITY VARIABLES (SUCH AS THE TYPE AND AMOUNT OF GUN POWDER). CARTRIDGE CASES THAT HAVE BEEN RELOADED AND FIRED MULTIPLE TIMES MAY SUFFER PHYSICAL DAMAGE WHICH COULD SIGNIFICANTLY IMPACT OR REDUCE THE INTEGRITY OF THE CARTRIDGE, POSSIBLY RESULTING IN BULLET SET-BACK OR UNSEATING. CASE FAILURE AND INJURY TO THE SHOOTER OR BYSTANDERS AND DAMAGE TO THE FIREARM MAY RESULT WHEN SUCH A ROUND IS FIRED. ANY AMMUNITION THAT IS IMPROPERLY MANUFACTURED OR RELOADED, EVEN IN THE SLIGHTEST DEGREE, MAY FAIL TO FIRE OR MAY GENERATE EXCESSIVE INTERNAL PRESSURES WHICH CAN DAMAGE OR EVEN RUPTURE THE FIREARM, CAUSING PERSONAL INJURY OR DEATH TO THE SHOOTER OR THOSE IN THE IMMEDIATE VICINITY.**

- A firearm and ammunition are a system and must work together. There are different types of ammunition for different types of firearms. Your firearm has been designed for ammunition of a specific type and a specific gauge or caliber. It is important to select the proper ammunition for your firearm.
- Different combinations of bullet velocity, bullet weight and firearm weight can have major impact on felt recoil; high felt recoil can be uncomfortable to some shooters.

For example:

- Firearm Weight: lower firearm weight increases felt recoil.
- Bullet Weight: higher bullet weight increases felt recoil.
- Bullet Velocity: higher bullet velocity increases felt recoil.

To acclimate yourself to higher levels of felt recoil, consider the following:

- Use a firm two-hand hold on the grip when firing.
- Always start your shooting experience with the lowest bullet velocity and lowest bullet weight available for your firearm.
- Ask your firearm dealer to suggest the lowest power, lowest velocity, lightest bullet weight for your firearm.

## AMMUNITION CONTINUED



**WARNING: NEVER USE AMMUNITION OF THE INCORRECT GAUGE OR CALIBER. USING AMMUNITION OF THE INCORRECT GAUGE OR CALIBER MAY CAUSE DAMAGE TO YOUR FIREARM AND POSSIBLE SERIOUS INJURY TO YOU AND TO OTHERS.**



**WARNING: NEVER USE CARTRIDGES OTHER THAN THOSE DESIGNATED BY THE MARKING ON THE FIREARM. DOING SO CAN RESULT IN DANGEROUSLY HIGH PRESSURES THAT MAY DAMAGE THE FIREARM AND POSSIBLY CAUSE SERIOUS INJURY TO YOURSELF AND OTHERS.**



**WARNING: DEATH, SERIOUS INJURY AND PROPERTY DAMAGE CAN RESULT FROM THE USE OF INCORRECT AMMUNITION OR BORE OBSTRUCTIONS. NEVER USE RELOADED AMMUNITION THAT HAS NOT BEEN SUBJECTED TO INTERNAL BALLISTIC PRESSURE TESTING.**

- “Plus-P” (+P) ammunition generates pressures in excess of the pressures associated with standard ammunition. Such pressures may affect the wear characteristics and may result in the need for more frequent service.
- “Plus-P-Plus” (+P+) ammunition must not be used in Smith & Wesson® firearms. This marking on the ammunition designates that it exceeds established industry standards, but the designation does not represent defined pressure limits and therefore such ammunition may vary significantly as to the pressures generated and could be DANGEROUS.

Marking on Firearm	Ammunition Type		
	Standard	+P	+P+
380 AUTO	OK	NO	NO
9mm	OK	OK	NO
9x21mm	OK	NO	NO
38 Super	OK	OK	NO
357 SIG	OK	NO	NO
40 S&W	OK	NO	NO
45 AUTO	OK	OK	NO

- Some brands of ammunition may cause difficulty in extracting spent cartridge cases from the chamber. If this situation occurs, thoroughly clean the chamber with solvent. If this condition persists, we recommend changing to another brand of ammunition.

# MODEL & FEATURES IDENTIFICATION

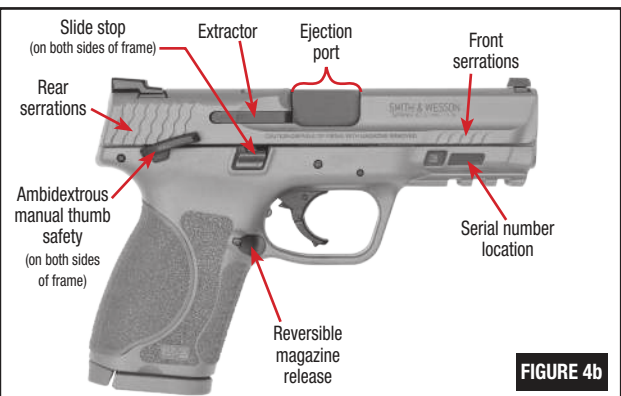
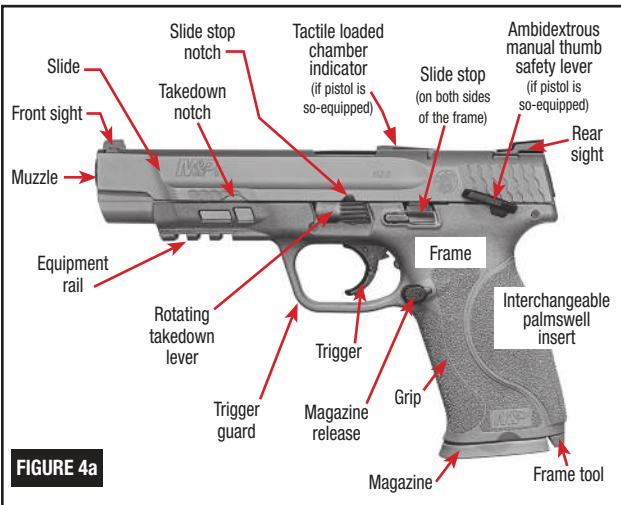
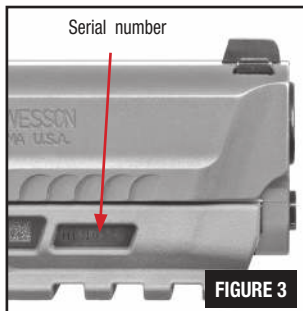
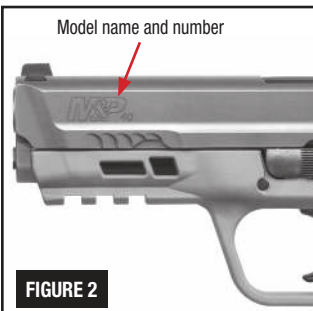

**WARNING: YOU MUST DETERMINE WHICH FEATURES ARE PRESENT ON YOUR SPECIFIC M&P® M2.0™ PISTOL AND HOW THOSE FEATURES OPERATE. VARIOUS MODELS OF THE M&P® M2.0™ PISTOLS ARE FITTED WITH DISTINCT FEATURES, WHICH INCLUDE: ONE OF SEVERAL LOADED CHAMBER INDICATORS AND A MANUAL THUMB SAFETY. SEE THE SECTIONS OF THIS MANUAL THAT DETAIL EACH OF THESE FEATURES.**

## INSPECTING YOUR PISTOL



**WARNING: ALWAYS ENSURE THAT THE FIREARM IS UNLOADED BEFORE INSPECTING, DISASSEMBLING, ASSEMBLING OR CLEANING AND ALWAYS KEEP THE MUZZLE OF THE FIREARM POINTED IN A SAFE DIRECTION.**

- When you inspect your pistol, you should first check for yourself to ensure that it is unloaded. Never take anyone's word for it.
- As shipped from the factory, an empty chamber flag is used to indicate that no round of ammunition is present in the chamber (FIGURE 5).
- Grasp the pistol with your finger off the trigger and outside the trigger guard, point the muzzle in a safe direction, depress the magazine release and remove the magazine from the pistol (FIGURE 6).
- Grasp the serrated sides of the slide from the rear with the thumb and fingers as shown (FIGURE 7) and briskly draw the slide fully rearward in order to extract any cartridge from the barrel chamber and clear it from the pistol. Do not obstruct the ejection port because doing so can interfere with complete ejection of a cartridge from the pistol.
- With the slide still held fully open, lock the slide in the open position by allowing the slide to move slightly forward from the rearmost position while pressing upward on the slide stop (FIGURE 8).
- Remove the empty chamber flag from the pistol (FIGURE 9).

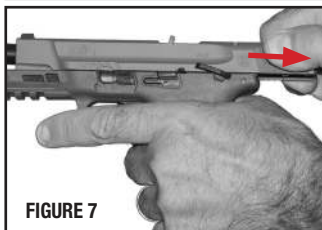
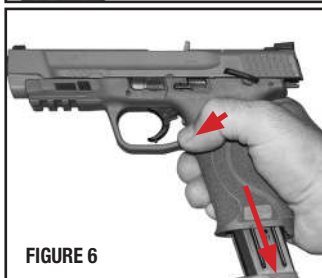
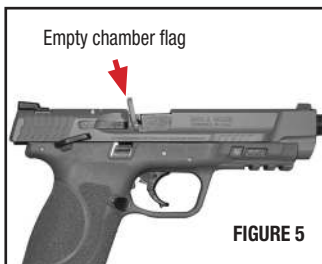

## INSPECTING YOUR PISTOL CONTINUED

- Check the barrel chamber and magazine well to verify that the pistol is unloaded (FIGURES 10 and 11)
- Check the bore for any obstructions. Remove any obstructions that are found.
- Before using your firearm for the first time, it should be cleaned.
- Examine the breech face to ensure that the firing pin is not protruding (FIGURE 12).
- If the firing pin is protruding (FIGURE 13), do not attempt to load or fire the firearm. Bring the pistol to a gunsmith qualified to perform service on Smith & Wesson® firearms.
- Unload the magazine by holding it with the bullet end of the cartridge pointing away from you and others and pressing each cartridge forward and out of the magazine (FIGURE 14).
- You must follow this procedure every time a firearm leaves your hand, is cleaned, handed to you or another person, transported or stored.

 **WARNING: NEVER RELY ON MECHANICAL FEATURES ALONE. ONLY YOUR SAFE GUN HANDLING WILL ENSURE THE SAFE USE OF YOUR FIREARM. THIS IS YOUR RESPONSIBILITY.**

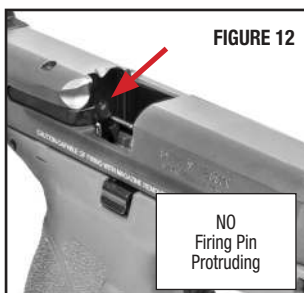
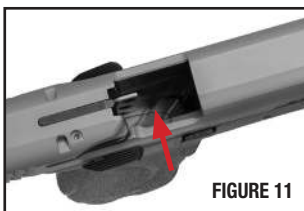

# MANUAL THUMB SAFETY

## For Those Models So-Equipped



**WARNING: NEVER RELY ON MECHANICAL FEATURES ALONE. ONLY YOUR SAFE GUN HANDLING WILL ENSURE THE SAFE USE OF YOUR FIREARM. THIS IS YOUR RESPONSIBILITY.**



**WARNING: IT IS YOUR RESPONSIBILITY TO CONTINUOUSLY EXAMINE YOUR PERSONAL SITUATION TO PROVIDE A SUFFICIENT LEVEL OF SAFETY.**

- The M&P® M2.0™ pistol is available with or without an ambidextrous manual thumb safety. FIGURE 81 shows the model with no manual thumb safety.

- If your pistol *has* a manual thumb safety lever (FIGURE 80), follow these instructions:



- The manual thumb safety prevents the trigger from moving rearward when the thumb safety lever is up in the “SAFE” position.

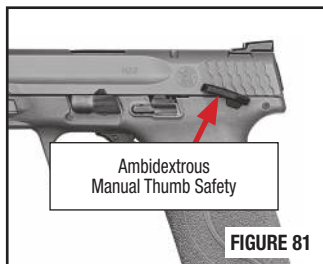

- Push the thumb safety lever fully upward to put it in “SAFE” position (FIGURE 82).

- Lower the thumb safety lever fully to put it in “FIRE” position allowing the pistol to be fired when the trigger is pulled (FIGURE 83).



- The slide can still be opened and closed regardless of the position of the safety lever.

- The magazine can be removed and installed in the pistol regardless of the position of the safety lever.



- The pistol can be loaded and unloaded regardless of the position of the safety lever.

## LOADED CHAMBER INDICATOR



**WARNING: NEVER RELY UPON THE LOADED CHAMBER INDICATOR ALONE TO VERIFY THE PRESENCE OR ABSENCE OF A ROUND IN THE CHAMBER. THE SUREST METHOD TO DETERMINE THE PRESENCE OR ABSENCE OF A ROUND IN THE CHAMBER IS TO VISUALLY CHECK THE CHAMBER OF YOUR FIREARM BY REMOVING THE MAGAZINE AND PULLING AND LOCKING THE SLIDE IN THE OPEN POSITION.**



**WARNING: ALWAYS TREAT EVERY FIREARM AS IF IT IS LOADED AND WILL FIRE IF THE TRIGGER IS PULLED. A LOADED CHAMBER INDICATOR MAY HELP DETERMINE WHETHER THE CHAMBER IS LOADED OR UNLOADED. THE AMOUNT OF LIGHT, CLEANLINES OF THE PISTOL, COLOR OF THE AMMUNITION AND OTHER FACTORS MAY LIMIT THE EFFECTIVENESS OF THE LOADED CHAMBER INDICATOR.**

- All M&P® M2.0™ pistols have a loaded chamber indicator, there are two types:

- **Type 1:** This indicator can be observed by looking at the top of the slide/ejection port, (FIGURE 15) noting an opening at the rear of the barrel hood. By looking into this opening, while keeping the pistol pointed in a safe direction, you can observe whether or not a round is in the firearm's chamber. If a round is in the chamber, you should be able to see the actual cartridge rim through this opening.



FIGURE 15

- **Type 2:** Some M&P® M2.0™ pistols are equipped with a tactile loaded chamber indicator. This indicator is present on the top of the slide. When the chamber is empty, the loaded chamber indicator will be flush with the top of the slide. When the chamber is loaded, the front of the loaded chamber indicator will protrude from the top of the slide where it can be felt above the slide's surface (FIGURES 16 and 17).

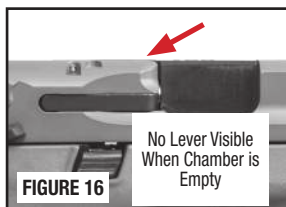

FIGURE 16

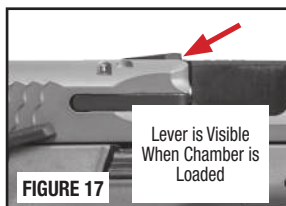

FIGURE 17



## PREPARATION FOR FIRING



**WARNING: YOU MUST DETERMINE WHICH FEATURES ARE PRESENT ON YOUR SPECIFIC M&P® M2.0™ PISTOL AND HOW THOSE FEATURES OPERATE. VARIOUS MODELS OF THE M&P® M2.0™ PISTOL ARE FITTED WITH DISTINCT FEATURES, WHICH MAY INCLUDE A MANUAL THUMB SAFETY AND ONE OF SEVERAL LOADED CHAMBERS INDICATORS. SEE THE SECTIONS OF THIS MANUAL THAT DETAIL THEIR USE.**

**THE PISTOL CAN BE FIRED WHEN THE MAGAZINE IS REMOVED FROM THE PISTOL. KEEP YOUR FINGER OFF THE TRIGGER AND OUTSIDE OF THE TRIGGER GUARD UNTIL YOU HAVE MADE THE COMMITMENT TO FIRE.**



**WARNING: FAILURE TO FOLLOW THESE FIREARM SAFETY REQUIREMENTS WILL CAUSE SERIOUS PERSONAL INJURY OR DEATH TO YOU OR OTHERS.**

- **ALWAYS TREAT ALL FIREARMS AS IF THEY ARE LOADED.**
- **ALWAYS BE SURE THAT THE CHAMBER IS CLEAR OF A CARTRIDGE, THE MAGAZINE IS REMOVED OR UNLOADED, AND THAT THE FIREARM IS POINTING IN A SAFE DIRECTION.**
- **ALWAYS KEEP FINGERS AND OTHER BODY PARTS AWAY FROM THE MUZZLE AND AWAY FROM THE PISTOL SLIDE, EJECTION PORT AND ANY BARREL PORTS OR COMPENSATORS ON THE FIREARM WHEN FIRING.** Failure to do so creates a risk of personal injury from bullets, hot gases from burning powder and/or debris spitting.
- **ALWAYS WEAR ADEQUATE AND PROPER HEARING PROTECTION SPECIFIED FOR FIREARM USE** to prevent permanent damage to your hearing. Make sure others who are nearby are wearing hearing protection as well.
- **ALWAYS WEAR SAFETY GLASSES SPECIFIED FOR USE WITH FIREARMS** whether indoors or out. Safety glasses should protect your eyes from the firing flash and particles associated with the discharge of ammunition. Failure to do so creates a risk of personal injury from particle or debris spitting or a ricochet.
- **ALWAYS BE ALERT AND ALWAYS FOLLOW THE SAFETY INSTRUCTIONS OF THE RANGE OFFICER.** Never shoot if you are tired, cold or impaired in any way.
- **THE SHOOTER (AND ALL OTHERS IN THE SHOOTING AREA) MUST ALWAYS BE IN A POSITION THAT IS OUT OF THE LINE OF FIRE** and are not within an area where they may be struck by a ricochet or particles spitting from a firearm, or by ejected cases.
- **ALWAYS BE AWARE OF OTHER PEOPLE** so that persons do not accidentally walk into the line of fire.
- **NEVER FIRE RANDOMLY INTO THE SKY.** Always select a place to shoot that has a safe backstop.

## PREPARATION FOR FIRING CONTINUED

- **NEVER SHOOT AT SURFACES THAT MAY CAUSE A RICOCHET.** Always select a place to shoot that has a safe backstop, is free from obstructions and has no surfaces which may cause a ricochet.
- **NEVER USE ALCOHOL OR DRUGS BEFORE OR WHILE SHOOTING OR HANDLING ANY FIREARM.**

## LOADING



**WARNING: ALWAYS KEEP THE MUZZLE POINTED IN A SAFE DIRECTION.**



**WARNING: VERIFY THAT THE FIRING PIN IS NOT PROTRUDING FROM THE BREECH FACE. IF THE FIRING PIN IS PROTRUDING, DO NOT ATTEMPT TO LOAD OR FIRE THE FIREARM. BRING THE PISTOL TO A GUNSMITH QUALIFIED TO PERFORM SERVICE ON SMITH & WESSON FIREARMS.**

- Do not load the pistol until you have read and fully understand this manual.
- Do not load the pistol until you are ready to use it. Keep your finger off the trigger and outside the trigger guard until you are ready to fire.
- Never load your pistol until you are sure of your target, what is beyond it and are fully prepared to fire.

**NOTE:** After inserting a magazine, always test to make sure it is locked in place by applying some removal pressure to the exposed portion of the magazine floor plate.

- Smith & Wesson® has provided you with a magazine designed to operate in your specific model of pistol. While your magazine may be able to be inserted into another model pistol, it will only function properly in the specific model for which it was designed. Do not interchange magazines from one model pistol to another model pistol.
- Follow instructions in this manual and any other specific instructions which may be marked onto, or accompany, a magazine. Failure to use the particular type of Smith & Wesson® magazine specified for your model and caliber of pistol may result in a malfunction.
- Load the magazine by pressing a cartridge head (rear of cartridge) downward on the forward portion of the magazine follower (or downward on the case of the previously loaded cartridge) and sliding the cartridge fully under the lips of the magazine until the cartridge head is against the rear wall of the magazine (FIGURE 18).

FIGURE 18

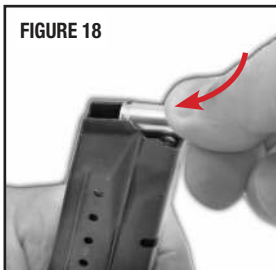

## LOADING CONTINUED

- Repeat this loading procedure for the number of cartridges you wish to load, up to the magazine capacity. Do not attempt to load your magazine with more than the specified number of cartridges because doing so can cause a feeding failure.
- Inspect your pistol as previously described in the “Inspecting Your Pistol” section. Hold the pistol in one hand with the muzzle pointing in a safe direction and with your finger off the trigger and outside the trigger guard. Insert the loaded magazine into the magazine well (opening) of the pistol until it is locked in place.



**WARNING: DO NOT USE EXCESSIVE UPWARD FORCE WHEN INSERTING A LOADED MAGAZINE INTO THE PISTOL. EXCESSIVE UPWARD FORCE COULD CAUSE THE SLIDE TO MOVE FORWARD, CHAMBERING A ROUND AND MAKING THE PISTOL READY TO FIRE.**

- To make sure that the magazine is fully and securely inserted, apply some removal pressure to the exposed portion of the magazine floor plate.
- Pull the slide to the rear and release it, allowing it to carry fully forward. This strips a cartridge from the magazine and seats it in the chamber of the barrel.



**WARNING: IF THE CARTRIDGE FAILS TO STRIP FROM THE MAGAZINE OR FULLY SEAT INTO THE CHAMBER, IMMEDIATELY STOP THE LOADING PROCESS. REMOVE THE MAGAZINE, LOCK THE SLIDE OPEN AND VERIFY THAT THE CHAMBER IS EMPTY. REFER TO THE “INSPECTING YOUR PISTOL” SECTION OF THIS MANUAL.**



**WARNING: ALWAYS LOAD A ROUND INTO THE CHAMBER BY FEEDING IT FROM THE MAGAZINE. FAILURE TO FOLLOW THIS WARNING CAN RESULT IN SEVERE INJURY OR DEATH TO YOU OR OTHERS. NEVER ATTEMPT TO LOAD THE PISTOL BY INSERTING A ROUND INTO THE OPEN EJECTION PORT.**

**CAUTION:** The pistol can now be fired by pulling the trigger to the rear.

- If you wish to restore the magazine in your pistol to its full capacity, depress the magazine release and remove the magazine from the pistol. Remember that there is a round in the chamber; therefore, the firearm should be holstered or safely secured during this process without touching the trigger. Load one cartridge into the magazine to replace the one which was chambered when you allowed the slide to move forward.



**WARNING: THIS M&P® M2.0™ PISTOL CAN BE FIRED WHEN THE MAGAZINE IS REMOVED FROM THE PISTOL. KEEP YOUR FINGER OFF THE TRIGGER AND OUTSIDE OF THE TRIGGER GUARD UNTIL YOU HAVE MADE THE COMMITMENT TO FIRE.**

## LOADING CONTINUED

- Reinsert the loaded magazine into the magazine well of the pistol until it is locked in place. To make sure that the magazine is again fully and securely inserted, apply some removal pressure to the exposed portion of the magazine floor plate.
- Your pistol and its magazine are now fully loaded and will fire when the trigger is pulled. Remember to keep your pistol pointed in a safe direction under all conditions and always keep your finger or any other object off the trigger and outside the trigger guard until you have made the commitment to fire the handgun. Never leave a loaded firearm out of your direct control.

## FIRING



**WARNING: ALWAYS KEEP THE MUZZLE POINTED IN A SAFE DIRECTION.**



**WARNING: UPON FIRING THE PISTOL OR RELEASING THE SLIDE FROM THE SLIDE STOP, THE SLIDE MOVES REARWARD OR FORWARD WITH SIGNIFICANT FORCE AND SPEED. TO AVOID INJURY, BE SURE NO PART OF YOUR BODY IS IN THE PATH OF THE SLIDE'S TRAVEL (FIGURE 19).**

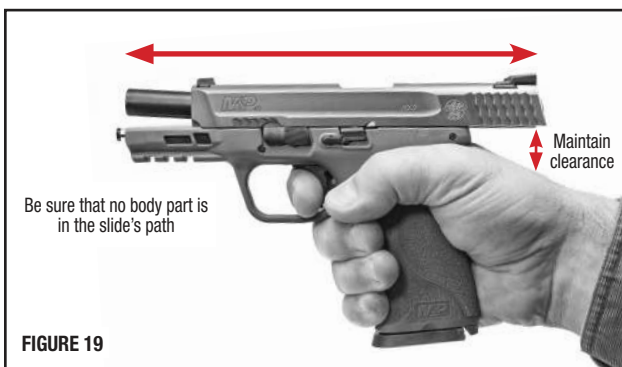

**WARNING: WEAR EYE AND HEARING PROTECTION SPECIFIED FOR FIREARM USE EVERY TIME YOU DISCHARGE YOUR FIREARM. MAKE SURE OTHERS IN THE VICINITY OF WHERE YOU WILL BE SHOOTING DO SO AS WELL.**

## FIRING CONTINUED



**WARNING: “STAGING” THE TRIGGER VIOLATES A BASIC RULE OF FIREARM SAFETY WHICH WARNS YOU TO KEEP YOUR FINGER OFF THE TRIGGER AND OUT OF THE TRIGGER GUARD UNTIL YOU HAVE MADE THE COMMITMENT TO FIRE. “STAGING” CREATES A SERIOUS RISK OF PERSONAL INJURY OR DEATH TO THE SHOOTER OR BYSTANDERS AND DAMAGE TO PROPERTY SINCE IT MAY LEAD TO AN UNINTENTIONAL DISCHARGE.**

- It has come to our attention that some users of Smith & Wesson® handguns may stage the trigger in anticipation of firing a shot. Staging is the act of pulling the trigger rearward – stopping just short of – the point where the handgun fires. Such manipulation of the trigger can reduce the user’s control of the handgun and can result in an unintentional discharge. Furthermore if the user decides not to fire, release of the trigger from a position close to the firing point in the staging process could result in an unintentional discharge.
- Keep the muzzle pointed in a safe direction and your finger outside the trigger guard until you are ready to fire. Each shot will be fired in the striker fire action mode. While holding the grip firmly, pull the trigger fully to the rear. As the trigger is drawn fully to the rear, the striker assembly is released, striking the cartridge primer. Upon firing, the slide moves rearward thereby extracting and ejecting the spent cartridge case (FIGURE 20). The slide then returns forward feeding the next cartridge from the magazine into the barrel chamber.
- After firing you must allow the trigger to move forward fully before you can fire another shot. Failure to do so will prevent the lockwork from fully cycling and will prevent your being able to fire the next shot. Keep your finger off the trigger and outside the trigger guard until you are ready to fire again. This sequence can be repeated until the last round has been fired, at which time the magazine follower exerts upward pressure on the slide stop causing it to engage the slide and to hold it in the “open” position.

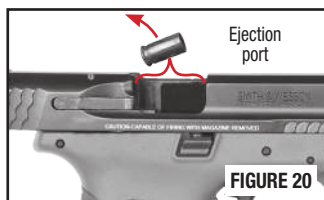

## HANGFIRES AND MISFIRES



**WARNING: ALWAYS KEEP THE MUZZLE POINTED IN A SAFE DIRECTION.**



**WARNING: WEAR EYE AND HEARING PROTECTION SPECIFIED FOR USE WITH FIREARMS WHEN FIRING AND CLEARING MISFIRES OR MISFEEDS.**



**WARNING: KEEP YOUR FACE A SAFE DISTANCE FROM THE EJECTION PORT WHEN CLEARING A CARTRIDGE. IF A CARTRIDGE IGNITES WHILE BEING CLEARED FROM THE FIREARM, DEATH OR SERIOUS INJURY MAY RESULT.**



**WARNING: IF YOUR FIREARM GIVES ANY INDICATION THAT IT IS NOT PERFORMING PROPERLY OR THE OPERATION OF YOUR FIREARM HAS CHANGED “THE WAY IT FEELS OR SOUNDS”, STOP FIRING. MAKE SURE THE FIREARM IS POINTED IN A SAFE DIRECTION, UNLOAD THE FIREARM AND HAVE IT INSPECTED AND TEST FIRED BY A GUNSMITH QUALIFIED TO PERFORM SERVICES ON SMITH & WESSON® FIREARMS.**

**NOTE:** In the case of either a hangfire or misfire, keep the muzzle pointed in a safe direction and your finger off the trigger. Wait 60 seconds, then press the magazine catch and remove the magazine from the pistol (FIGURE 21). Proceed to clear the unfired cartridge from the chamber.



- **A HANGFIRE** is described as a noticeable delay between the impact of the firing pin on the primer of the cartridge and the actual discharge of the firearm. This is generally caused by defective or damaged ammunition.
- If a cartridge has delayed ignition and goes off after a delay, with the firearm pointed in a safe direction, the magazine should be removed and the firearm should be unloaded. The remainder of similar ammunition should be inspected to determine if it has been contaminated or damaged and dealt with accordingly.
- **A MISFIRE** is the failure of the chambered cartridge to fire at all after the trigger has been pulled. This is generally caused by defective or damaged ammunition or a dirty or fouled firearm.

## HANGFIRES AND MISFIRES CONTINUED

- A light primer strike caused by a dirty or fouled firearm can lead to misfires. If a light indent on the primer of a misfire is noted, unload the firearm and clean it as instructed in the Cleaning and Maintenance section of this manual. If the cartridge does not go off, the “dud” cartridge needs to be removed from the firearm.

- With the magazine removed from the pistol, pull the slide all the way back (FIGURE 22) to remove the round from the chamber.



- Press up on the slide stop and let the slide move forward against the slide stop to lock the slide open (FIGURE 23).



- Visually check the chamber and the magazine well to be certain that no cartridges are present (FIGURES 24 and 25).

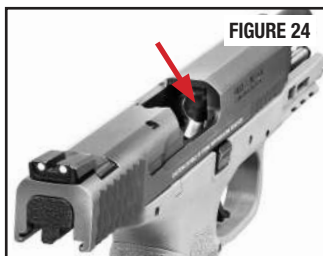

- The firearm should be inspected and cleaned before returning it to use.

- The ammunition should be inspected and any damaged or defective rounds should not be used.

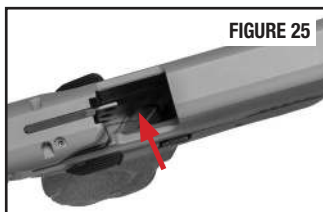

- Dispose of defective cartridge(s) in a method specifically approved for live round disposal.



**WARNING: YOUR M&P® M2.0™ PISTOL CAN BE FIRED WHEN THE MAGAZINE IS REMOVED FROM THE PISTOL. KEEP YOUR FINGER OFF THE TRIGGER AND OUTSIDE OF THE TRIGGER GUARD UNTIL YOU HAVE MADE THE COMMITMENT TO FIRE.**

## CLEARING A MISFEED/JAM

**NOTE:** Any autoloading firearm may, on occasion, fail to feed a cartridge properly from the magazine and into the chamber. If this should occur:



**WARNING: KEEP YOUR FACE A SAFE DISTANCE FROM THE EJECTION PORT WHEN CLEARING A MISFEED/JAMMED CARTRIDGE. A CARTRIDGE MAY IGNITE IF THE PRIMER OF THE CARTRIDGE IS STRUCK WITH SUFFICIENT FORCE. IF A CARTRIDGE IGNITES WHILE BEING CLEARED FROM THE FIREARM, DEATH OR SERIOUS INJURY MAY RESULT.**

### TO CLEAR A MISFEED (“JAM”)

- Make certain that the muzzle is pointed in a safe direction.

- Press the magazine catch and remove the magazine from the pistol (FIGURE 26).



FIGURE 26

- Pull the slide fully rearward and engage the slide stop (FIGURE 27) to lock the slide open.

**NOTE:** Drawing the slide fully to the rear should allow clearance for the jammed cartridge to fall free and clear of the firearm.



FIGURE 27

- It may be necessary to manually remove a jammed cartridge. When attempting to clear a jam manually, use only wood ‘tools’, such as a pointed dowel or a pencil, and use extreme care to avoid striking the primer of the cartridge.
- Visually check to make sure all cartridges have been removed from the firearm.
- Once the jammed cartridge is cleared, proceed to load the firearm as instructed in the Loading Section of this manual.
- Dispose of defective cartridge(s) in a method specifically approved for live round disposal.



# UNLOADING



**WARNING: ALWAYS KEEP YOUR PISTOL POINTED IN A SAFE DIRECTION. ALWAYS KEEP YOUR FINGER OFF THE TRIGGER AND OUTSIDE THE TRIGGER GUARD WHEN UNLOADING.**

- Point the muzzle in a safe direction. Make sure your finger is off the trigger and out of the trigger guard. Depress the magazine release and remove the magazine (FIGURE 28).
  - Keep the muzzle still pointed in a safe direction, and keep your finger off the trigger and outside the trigger guard, grasp the serrated sides of the slide from the rear with the thumb and fingers, (FIGURE 29) and briskly draw the slide fully rearward in order to extract any cartridge from the barrel chamber and clear it from the pistol.
  - Lock the slide in the open position by allowing the slide to move slightly forward from the rearmost position while pressing upward on the slide stop (FIGURE 30).
- NOTE:** Do not obstruct the ejection port because doing so can interfere with ejection of a cartridge.
- Visually check the barrel chamber to make sure that it is empty (FIGURE 31).
  - Look into the chamber and down through the magazine well. Verify that no ammunition remains in the pistol (FIGURE 32).
  - Unload the magazine by holding it with the bullet end of the cartridge pointing away from you and pressing each cartridge forward and out of the magazine (FIGURE 33).



FIGURE 28



FIGURE 29



FIGURE 30

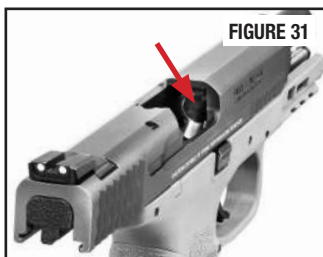

FIGURE 31

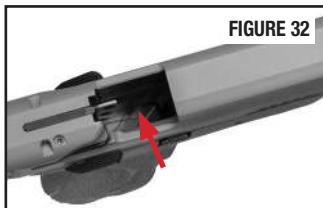

FIGURE 32



FIGURE 33

## FIELD STRIPPING/DISASSEMBLY



**WARNING: ALWAYS KEEP THE MUZZLE POINTED IN A SAFE DIRECTION.**



**WARNING: ALWAYS FOLLOW THE FIELD STRIPPING INSTRUCTIONS EXACTLY. NEVER DO ANYTHING BEYOND WHAT YOU ARE SPECIFICALLY INSTRUCTED TO DO IN THIS MANUAL. NEVER ALTER OR MODIFY THE PARTS IN YOUR PISTOL.**



**WARNING: WEAR SAFETY GLASSES EVERY TIME YOU ASSEMBLE OR DISASSEMBLE YOUR FIREARM.**

- Point the muzzle in a safe direction. Make sure your finger is off the trigger and out of the trigger guard. Depress the magazine release and remove the magazine (FIGURE 34).



FIGURE 34

- With the barrel still pointing in a safe direction, and with your finger off the trigger and outside the trigger guard, grasp the serrated sides of the slide from the rear with the thumb and fingers (FIGURE 35) while holding the firearm in an upright position, briskly draw the slide fully rearward in order to extract any cartridge from the barrel chamber and clear it from the pistol.



FIGURE 35

- Pull the slide fully to the rear, press upward on the slide stop while letting the slide move slightly forward thereby locking the slide open (FIGURE 36).



FIGURE 36



**WARNING: MAKE SURE THE HANDGUN IS UNLOADED BEFORE PROCEEDING WITH FIELD STRIPPING.**

## FIELD STRIPPING / DISASSEMBLY CONTINUED

- Remove the frame tool from the bottom of the grip by turning it 90 degrees (in either direction) and pulling it out of the frame (FIGURE 37).
- Remove the interchangeable palmswell backstrap insert from the frame by tipping it away from the frame - bottom first to release the tab at the top that engages the frame (FIGURE 38).
- Use the frame tool provided (or a similar device) to push the sear deactivation lever down into the lowered position (FIGURES 39 through 42).

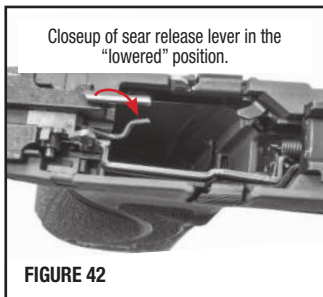
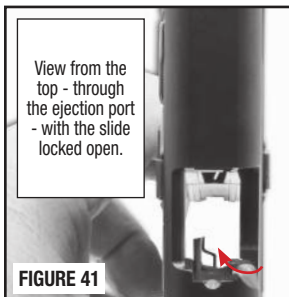
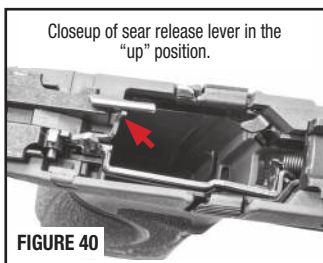
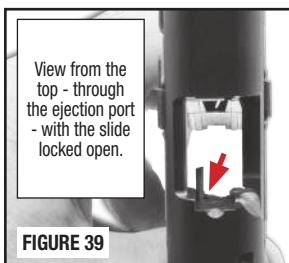

**NOTE:** The sear deactivation lever is yellow/green in color.

- Rotate the takedown lever clockwise (FIGURE 43).



## FIELD STRIPPING / DISASSEMBLY CONTINUED

- Grasp the slide from the top as shown and remove the slide from the frame by pulling it slightly rearward then forward while being careful to retain the recoil spring and guide rod assembly (FIGURE 44).



- Remove the recoil spring from below the barrel (FIGURE 45).

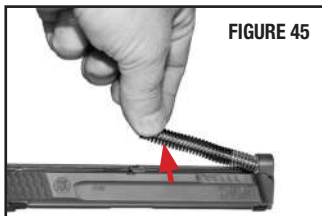

- Remove the barrel from the bottom of the slide (FIGURE 46).

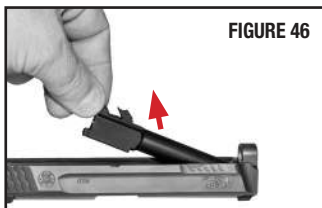

- FIGURE 47 shows the parts that you will have after field stripping the pistol.

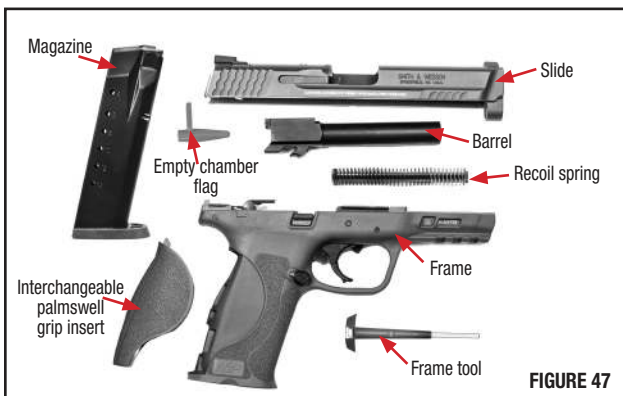

**WARNING: DO NOT ALTER, MODIFY OR REPLACE ANY OF THE PARTS OF YOUR FIREARM UNLESS THIS WORK IS PERFORMED BY A QUALIFIED GUNSMITH USING GENUINE SMITH & WESSON® PARTS. IF YOU DO OTHERWISE, IMPROPER FUNCTIONING MAY OCCUR AND SERIOUS INJURY MAY RESULT.**

**WARNING: NEVER DISASSEMBLE YOUR HANDGUN BEYOND THE FIELD STRIPPING PROCESS OUTLINED IN THIS MANUAL. NEVER MANIPULATE ANY INTERNAL COMPONENTS BEYOND WHAT YOU ARE SPECIFICALLY INSTRUCTED TO DO IN THIS MANUAL SINCE THIS MAY AFFECT THE RELIABILITY, FUNCTIONING AND SAFETY OF YOUR HANDGUN.**

## LUBRICATION

- There are eight (8) lubrication points where a single drop of high-quality firearms lubricant should be applied. This will ensure proper lubrication. Care should be taken not to over-lubricate. Excess lubricant can collect quantities of unburned powder and carbon residue, which could interfere with proper functioning of the pistol (FIGURES 48 and 49).

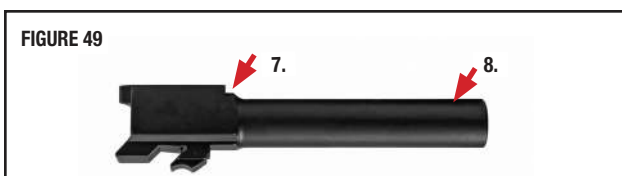
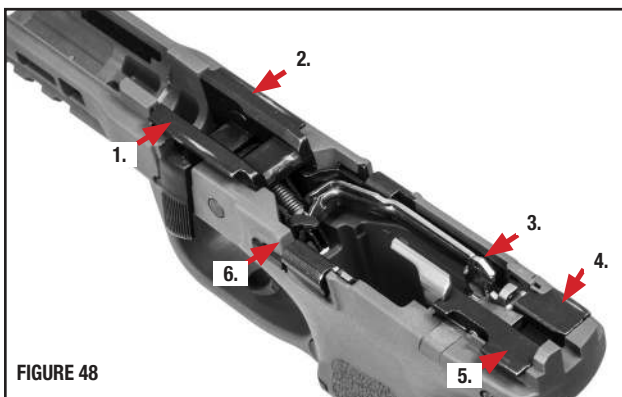

## ASSEMBLY

**WARNING: ALWAYS FOLLOW THESE INSTRUCTIONS EXACTLY. NEVER DO ANYTHING BEYOND WHAT YOU ARE SPECIFICALLY INSTRUCTED TO DO IN THIS MANUAL. NEVER ALTER OR MODIFY THE PARTS IN YOUR PISTOL.**

**WARNING: WEAR SAFETY GLASSES EVERY TIME YOU ASSEMBLE OR DISASSEMBLE YOUR FIREARM.**

- Replace the barrel in the slide so the muzzle is flush with the end of the slide and the barrel lug is turned up away from the ejection port (FIGURE 50).



## ASSEMBLY CONTINUED

- Insert the protruding button (smaller end) (FIGURE 51) of the recoil spring guide assembly into the slide guide housing (muzzle end) and the rear of the spring into the assembly (FIGURE 52).

FIGURE 51



- Make sure the recoil spring assembly is properly centered as shown (FIGURES 53 through 56).

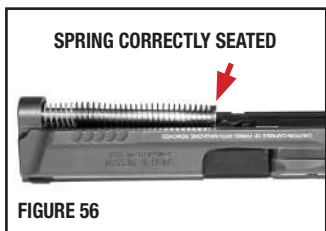
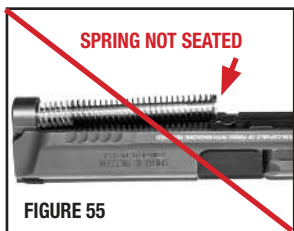
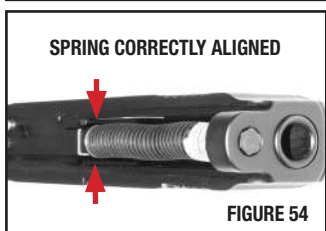
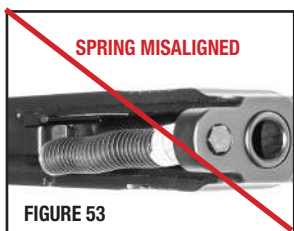

- Verify that the sear deactivation lever is in the lowered position; it must be protruding into the magazine well as shown (FIGURE 57).



## ASSEMBLY CONTINUED

- Verify that the slide stop is in the down position (FIGURE 58). The slide stop can be easily pressed down if it has locked in the up position (FIGURE 59) while the slide was off the frame.
- Holding the slide and recoil spring guide firmly in one hand, with the takedown lever down, place the rear of the slide onto the front frame rails (FIGURE 60).
- Continue pulling the slide onto the rear frame rails (FIGURE 61) until the slide is fully rearward.
- Press upward on the slide stop while letting the slide move slightly forward thereby locking the slide open (FIGURE 62).
- Rotate the takedown lever fully upward (FIGURES 63 and 64) before allowing the slide to move forward to the closed position.
- Replace the frame tool into the base of the grip.
- Replace the empty magazine into the pistol - which returns the sear deactivation lever to normal operation mode.
- Check for proper functioning by drawing the slide fully rearward - at which point the slide stop should move up and hold the slide open.



# INTERCHANGEABLE PALMSWELL GRIP INSERTS



**WARNING: ALWAYS KEEP THE BARREL POINTED IN A SAFE DIRECTION.**



**WARNING: MAKE SURE THE HANDGUN IS UNLOADED BEFORE CHANGING THE INTERCHANGEABLE PALMSWELL GRIP INSERTS.**

- If the interchangeable palmswell grip insert currently on your pistol does not fit your hand comfortably, you can install one of the four different sizes that come with each pistol (Small, Medium, Medium-Large and Large).
- Remove the magazine from the pistol to gain access to the frame tool.
- Remove the frame tool from the bottom of the grip by rotating it 1/4 turn (either direction) and pulling it down and out of the frame (FIGURE 65).
- Take the current interchangeable palmswell grip insert off the handgun and replace it with the appropriate interchangeable palmswell insert (FIGURE 66).
- Replace the frame tool.
- Replace the magazine into the pistol.

**CAUTION:** Some solvents may cause damage to the interchangeable palmswell insert material. See the “Cleaning and Maintenance” section of this manual for more information.

**NOTE:** The pistol comes with interchangeable palmswell grip inserts in Small, Medium, Medium-Large and Large sizes. The size of each is marked on both the inside surface and the outside of the interchangeable palmswell grip insert (FIGURES 67 and 68).



FIGURE 65



FIGURE 66

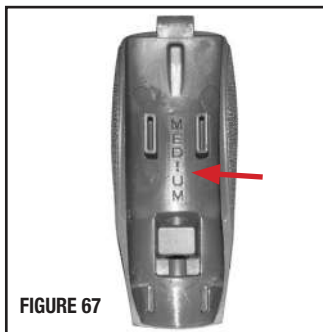

FIGURE 67

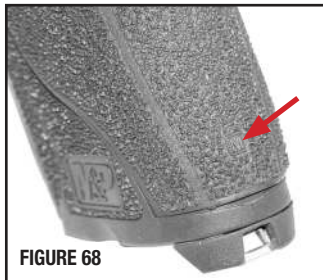

FIGURE 68



## REVERSIBLE MAGAZINE RELEASE

- The magazine release (FIGURE 69) can be installed to operate from the right or left side. To reverse the magazine release, follow these instructions:

Magazine release removed from pistol to show spring retainer notch



FIGURE 69

- The mechanism that retains the magazine catch is located inside the magazine well (FIGURE 70). Field strip the pistol to gain access to the magazine release spring.

Access to Magazine Release Spring



FIGURE 70

- Move the magazine release spring from the magazine release notch (FIGURES 71 and 72). The frame tool or a small screwdriver will work to move the rod/spring out of its notch and around the raised part of the magazine release.

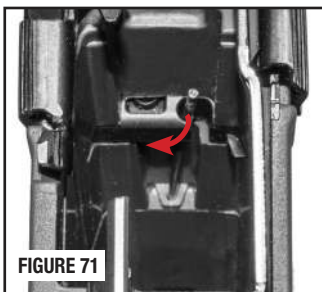

FIGURE 71

- Slide the magazine release half-way out of the frame and hold it steady while moving the spring around the raised end of the magazine release (FIGURE 73).

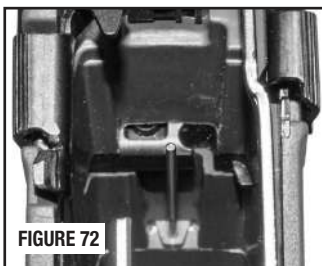

FIGURE 72

- Slide the magazine release all the way out of the frame and re-install it in the desired orientation. Insert the magazine release from the right or left side of the frame according to your preference.

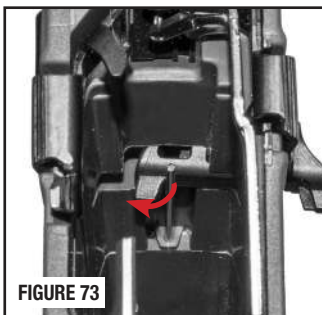
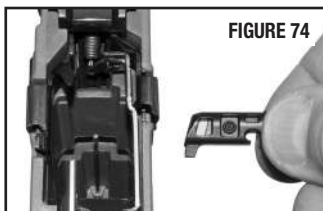

FIGURE 73

**NOTE:** The textured end of the magazine release should be on the side that you want it to function from.

## REVERSIBLE MAGAZINE RELEASE CONTINUED

- Insert the magazine release from the right or left side of the frame according to your preference (FIGURE 74).



- Move the magazine release spring into the magazine release recess (FIGURE 75).

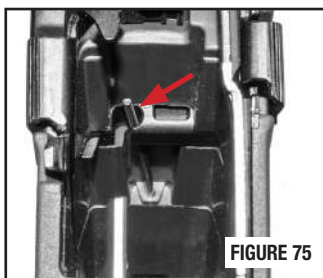

- Check for proper function.

## MAGAZINE



**WARNING: WEAR SAFETY GLASSES EVERY TIME YOU ASSEMBLE OR DISASSEMBLE YOUR MAGAZINE.**



**WARNING: THE MAGAZINE SPRING IS UNDER PRESSURE. CONTROL THE SPRING AND FOLLOWER SO THAT THEY DO NOT FLY OUT AND CAUSE INJURY.**

### MAGAZINE DISASSEMBLY

- Using a pointed tool, depress floor plate catch through the hole in the floor plate (FIGURE 76).
- Slide floor plate forward off of the tube while holding floor plate catch in the tube (FIGURE 77) against spring pressure.
- Remove floor plate catch and spring and follower out through bottom of tube.
- Turn the tube right side up and remove spring and follower through bottom of the tube.



## MAGAZINE CONTINUED

- FIGURE 78 shows the parts of the magazine.

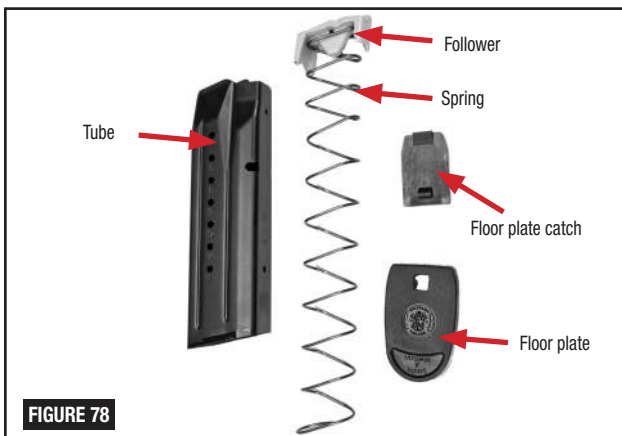

### MAGAZINE ASSEMBLY

- Install magazine spring and follower and floor plate catch front to back into the tube in exactly the same orientation as they were in when they were first removed during disassembly.
- Holding floor plate catch in the tube, slide the floor plate onto the tube's base so that the projection of the floor plate catch engages the floor plate. Verify that the floor plate is locked in place by exerting some pressure on the floor plate - as if trying to slide it off the tube.

## SIGHT ADJUSTMENT



**WARNING: ENSURE YOUR FIREARM IS UNLOADED BEFORE ADJUSTING YOUR SIGHTS. AT ALL TIMES FOLLOW THE BASIC FIREARMS SAFETY RULES IN THE SECTION ENTITLED "YOUR SAFETY RESPONSIBILITIES".**

- If the rear sight has a set screw, loosen the set screw prior to moving the rear sight. Tighten the set screw after the sight has been adjusted to the desired position (FIGURE 79).
- The rear sight is adjustable for windage only. To adjust, move the rear sight in the direction you wish the group to move on the target. For example, if the group should move to the right, move the rear sight to the right. Use a brass or plastic drift or punch to prevent marring the rear sight.



## CLEANING AND MAINTENANCE



**WARNING: ENSURE THAT YOUR FIREARM IS UNLOADED BEFORE BEGINNING TO CLEAN IT. (SEE “INSPECTING YOUR FIREARM” SECTION). ALWAYS FOLLOW THE RULES OF SAFE GUN HANDLING.**



**WARNING: WEAR SAFETY GLASSES EVERY TIME YOU ASSEMBLE OR DISASSEMBLE YOUR FIREARM AND ATTEMPT CLEANING OR MAINTENANCE.**

- Before using your firearm for the first time, it should be cleaned.
- Your firearm was treated at the factory with either a preservative or oil to protect it against corrosion during shipping and storage.
- Preservative and oil should be wiped from the bore, chamber and exposed areas using a clean swab or patch before using the firearm.

**CAUTION:** Never disassemble your firearm beyond the instructions in the Field Stripping and Inspection sections of this manual.

- Purchase cleaning supplies from your firearms dealer that are specifically designated for your type and caliber of firearm. Many suppliers offer these in kit form for your convenience.
- Follow the instructions provided with your cleaning supplies.

**NOTE:** A basic firearm cleaning kit should include: a brass bore brush and a cleaning jag of appropriate size for the bore being cleaned, high-quality gun cleaning solvent and gun oil/lubricant, cotton cleaning patches and a cleaning rod that is long enough to push the brush and jag completely through the barrel.

- Remove excessive firing residue from the bore and chamber using a properly fitted brass brush dipped in gun cleaning solvent. Finish the bore cleaning process by running a dry cotton cloth patch through the bore to remove residue and solvent.
- Clean the exterior of the firearm using a non-abrasive cleaning cloth.
- After cleaning, lightly coat the metal parts, internal and external with a high quality gun oil. Refer to the “Lubrication” section in this manual for instructions on lubricating the firearm.
- Whenever your firearm has been exposed to sand, dust, extreme humidity, water or other adverse conditions, it must be cleaned and lubricated.

## CLEANING AND MAINTENANCE CONTINUED



**WARNING: ALWAYS HAVE ADEQUATE VENTILATION. CLEANING FIREARMS IN POORLY VENTILATED AREAS, DISCHARGING FIREARMS, OR HANDLING AMMUNITION MAY RESULT IN EXPOSURE TO LEAD AND OTHER SUBSTANCES KNOWN TO CAUSE BIRTH DEFECTS, REPRODUCTIVE HARM, AND OTHER SERIOUS PHYSICAL INJURY. WASH HANDS THOROUGHLY AFTER EXPOSURE.**

**CAUTION:** Always follow the instructions provided with your gun cleaner and gun lubricant.

**CAUTION:** Some cleaners can cause damage to your firearms. You should avoid prolonged solvent immersion and prolonged ultrasonic cleaning of your firearm. Choice of solvent should be restricted to those products specifically developed for firearms maintenance. Damage to a firearm's finish may occur if these cautions are ignored. Ammoniated solvents or other strong alkaline solvents, should not be used on any Smith & Wesson® firearm.

- Cleaning is essential to ensure the proper functioning of your firearm.
- Your firearm is a precision instrument. To ensure reliable function it is necessary to follow a routine maintenance procedure. After firing your firearm, be sure to unload it following the procedure outlined in the section entitled "Inspecting Your Firearm" before performing any cleaning or maintenance procedure.
- Remove any gun cleaning solution, oil and fingerprints from the outside surfaces of the firearm. (Finger moisture, if left, could start a corrosion process).



**WARNING: NEVER MANIPULATE, ADJUST OR CHANGE ANY OF THE INTERNAL COMPONENTS OF YOUR FIREARM UNLESS SPECIFICALLY DIRECTED TO DO SO IN THIS MANUAL. IMPROPER MANIPULATION OF ANY INTERNAL COMPONENT MAY AFFECT THE SAFETY AND RELIABILITY OF YOUR FIREARM AND MAY CAUSE SERIOUS INJURY OR DEATH.**



**WARNING: ANY MAINTENANCE OR SERVICE NOT SPECIFIED IN THIS MANUAL MUST BE PERFORMED BY A QUALIFIED GUNSMITH USING GENUINE SMITH & WESSON® PARTS. IF YOU DO OTHERWISE, IMPROPER FUNCTIONING OF YOUR FIREARM MAY OCCUR AND SERIOUS INJURY OR DEATH MAY RESULT.**

- If your firearm will be used in a cold climate, be sure to use an oil of an appropriate weight so that it will not congeal in cold temperatures, causing the interaction of important parts to be slowed or halted.

---

## CLEANING AND MAINTENANCE CONTINUED

---

### MAINTENANCE BEFORE STORAGE

- When storing, do not encase your firearm in anything that will attract or hold moisture, for example, leather or heavy cloth. Also, do not store guns with a plug inserted in the barrel for this can be a contributing factor to moisture accumulation. If your firearm is to be stored for an extended period, the bore, chambers and internal working mechanism should be oiled with a high quality lubricating oil or preservative intended for firearms. The external working mechanisms and barrel should be coated with an anti-rust oil. Before using your firearm again, be sure to clean it. Every time you clean your firearm, check it for signs of wear. If wear is noted, do not use the firearm. Return it to Smith & Wesson® for service or have it checked by a qualified gunsmith.

---

## LIMITED WARRANTY

### For Owners Within The United States.

---

This warranty is granted by Smith & Wesson Inc. This warranty is effective from the date of purchase and applies to the original owner of any firearm. With respect to such firearms, this warranty supersedes any and all other warranties.

Smith & Wesson® firearms are warranted to be free from defects in material and workmanship. Any such defects of which Smith & Wesson receives written notice within one year from the date of purchase by the original owner, will be remedied by Smith & Wesson without charge within a reasonable time after such notification and delivery of the firearm as provided below.

In the event of an emergency (repairs needed by law enforcement, an upcoming match or hunting trip), call 1-800-331-0852, ext. 4125 and ask for 911 Priority Repair Service. This allows you to speak with a Smith & Wesson® representative. Immediately upon receipt, your firearm will be assigned to a gunsmith. After the work is completed, we will return your Smith & Wesson® firearm via overnight delivery.

To submit a warranty claim please see the “Contact and Shipping Information” below for details. In addition to the requested information, please include a copy of the bill of sale in the owner’s name, or a copy of the ATF Form 4473 indicating date of purchase. It is always important that the owner comply with all applicable federal, state and local laws and regulations.

Warranty claims should state the model and serial number of the firearm concerned and the description of the difficulty experienced. It is recommended that shipments be insured by the owner, since Smith & Wesson® will accept no responsibility for loss or damage in transit. Transportation and insurance charges for return to owner will be paid by Smith & Wesson® if the claim is covered by the warranty.

## LIMITED WARRANTY CONTINUED

UNDER NO CIRCUMSTANCES SHALL SMITH & WESSON® BE RESPONSIBLE FOR INCIDENTAL OR CONSEQUENTIAL DAMAGES WITH RESPECT TO ECONOMIC LOSS, INJURY, DEATH OR PROPERTY DAMAGE, WHETHER AS A RESULT OF BREACH OF THIS WARRANTY, NEGLIGENCE OR OTHERWISE.

Some states do not allow the exclusion or limitation of incidental or consequential damages, so the above limitation or exclusion may not apply to you.

Smith & Wesson® will ***NOT*** be responsible for:

- Defects or malfunctions resulting from careless handling, unauthorized adjustments or modifications made or attempted by anyone other than a qualified gunsmith following Smith & Wesson® authorized procedures, or failure to follow the disassembly instructions in the Smith & Wesson® manual.
- Use of defective or improper ammunition, corrosion, neglect, abuse, ordinary wear and tear, or unreasonable use.
- Criminal misuse, negligence or use under the influence of drugs or alcohol.

Smith & Wesson's Lifetime Service Policy begins after the warranty period has expired. Smith & Wesson will repair, without charge, for the lifetime of the original owner, any Smith & Wesson® handgun purchased on or after February 1, 1989, and any M&P series rifle that is found to have a defect in material or workmanship. Eligibility for this Lifetime Service Policy requires returning the printed Product Registration Card within 30 days of purchase or registering the purchase online within 30 days of purchase at [www.smith-wesson.com](http://www.smith-wesson.com). The Lifetime Service Policy covers functional defects; it does not include the firearm's finish, grips, magazines or sights. The Lifetime Service Policy is in addition to and not an extension of the Smith & Wesson® Warranty.

This warranty gives you specific legal rights. You may also have other rights that vary from State to State.

**NOTE:** All liability is excluded in the event that the instructions in the Smith & Wesson® manual are not observed.

## **CONTACT AND SHIPPING INFORMATION**

### **For Owners Within The United States**

**NOTE:** A Return Merchandise Authorization (**RMA**) is the first step in the process of returning a product in order to receive a repair, replacement or refund. Please contact Smith & Wesson's Customer Service Dept. (via e-mail: [qa@smith-wesson.com](mailto:qa@smith-wesson.com) or by phone at 800-331-0852 ext. 4125) to obtain authorization to return your firearm so we can process it quickly and efficiently. The RMA number that is supplied by Smith & Wesson® must be displayed on the outside of the returned product's packaging; returns without an RMA number will be routed differently which will result in delayed processing.

The Return Merchandise Authorization (**RMA**) process allows Smith & Wesson an opportunity to try to diagnose and correct a customer's concerns with the product (such as ammunition problems) before it is returned. Accordingly, please contact us before returning your Smith & Wesson firearm.

#### **CONTACT CUSTOMER SERVICE**

**Tel: 800-331-0852 ext. 4125**

**E-mail: [qa@smith-wesson.com](mailto:qa@smith-wesson.com)**

#### **RETURNS - FOR SERVICE**

#### **ALL SMITH & WESSON FIREARMS**

**Smith & Wesson  
2100 Roosevelt Avenue  
Springfield, MA 01104**

Should your Smith & Wesson® firearm require service, it should be returned to the Smith & Wesson factory.

- Call or e-mail the Customer Service Dept. for authorization and shipping instructions.
- Ensure that the firearm is unloaded.
- **Do not attempt to ship a firearm via US Postal Service; only federally licensed dealers may ship a firearm by US Postal Service.**
- **DO NOT SHIP ANY AMMUNITION.**
- Enclose a letter which includes your full name and address (no P.O. Boxes, please), daytime telephone number, e-mail address, the serial number of the firearm, and details of the problem experienced (stating the brand and type of ammunition used when the problem occurred) or work desired.
- Record the serial number before shipping, in case you wish to check on the repair status of your firearm.



## CONTACT AND SHIPPING CONTINUED

- Please remove all custom parts and accessories, such as stocks, special sights and scopes, or holsters from your firearm before returning.
- Place the firearm in its original case or in a similarly secure container and pack it securely.
- The package must **NOT** bear any markings which indicate the identity of the contents.
- It is most important that you comply with federal, state, and local laws and regulations. The following guidelines are meant to help, but you must seek assistance from the appropriate authorities if necessary.
- If your firearm must be replaced, it may be necessary to ship the replacement to a dealer rather than directly to you. You will be requested to furnish a signed FFL (Federal Firearms License) from your dealer in such an instance.
- Warranty repair work will begin upon receipt and examination of the firearm. In the case of repairs or work not covered by the warranty, a quotation covering the cost of the work plus round trip transportation charges will be sent to you. Repairs or modification will be scheduled upon receipt of payment.
- A parts list can be obtained by contacting Smith & Wesson® Customer Service.



**WARNING: YOU MAY PURCHASE ACCESSORIES FOR YOUR SMITH & WESSON® FIREARM. YOU MUST HAVE SOME OF THESE PARTS INSTALLED BY A GUNSMITH QUALIFIED TO PERFORM SERVICE ON SMITH & WESSON FIREARMS. YOU MUST NEVER ATTEMPT TO MODIFY YOUR FIREARM OR INSTALL REPLACEMENT PARTS IN YOUR FIREARM. ALWAYS USE A QUALIFIED SMITH & WESSON® GUNSMITH EVEN IF THE REPAIR SEEMS SIMPLE.**

# C.O.R.E.™ OPTICAL SIGHT ADAPTER MOUNTING INSTRUCTIONS

## For Use On M&P® M2.0™ C.O.R.E.™ Pistols Only



**WARNING: ALWAYS KEEP YOUR FIREARM POINTED IN A SAFE DIRECTION. NEVER POINT A FIREARM AT ANYTHING YOU DO NOT INTEND TO SHOOT.**



**WARNING: NEVER ATTEMPT TO INSTALL A SIGHT MOUNT ON A LOADED FIREARM. ALWAYS ENSURE THAT THE FIREARM IS NOT LOADED.**



**WARNING: WEAR SAFETY GLASSES SPECIFIED FOR USE WITH FIREARMS WHEN INSTALLING OR REMOVING THE OPTICAL SIGHT OR WHEN FIRING YOUR PISTOL WITH THE OPTICAL SIGHT INSTALLED.**



**WARNING: FAILURE TO HEED THESE WARNINGS MAY RESULT IN INJURY AND/OR DEATH TO THE USER OR BYSTANDERS AND DAMAGE TO PROPERTY.**

**NOTE:** USE THE TABLE ON PAGES 44 AND 45 OF THIS MANUAL TO MATCH THE MOUNTING PLATE AND SCREWS FOR YOUR SPECIFIC SIGHT.

- Follow the instructions provided with your specific sight for correct mounting and use of that sight.

Step 1: Remove the plastic slide cap from the M&P® M2.0™ pistol slide by unscrewing the two screws using a 5/64" hex wrench as shown here (FIGURES 80 and 81).

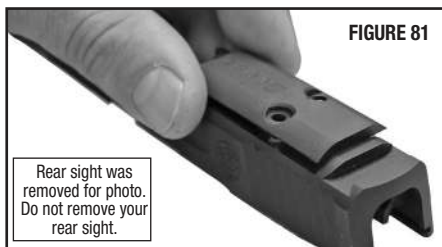

- If you have any questions about the installation of an optical sight on your M&P® M2.0™ pistol using this system, contact the Customer Service Department at 1-800-331-0852, ext. 4125.

## C.O.R.E.™ MOUNTING INSTRUCTIONS CONTINUED

### For Use On M&P® M2.0™ C.O.R.E.™ Pistols Only

Step 2: Install the provided spacer plate for your particular optic as shown (FIGURE 82).

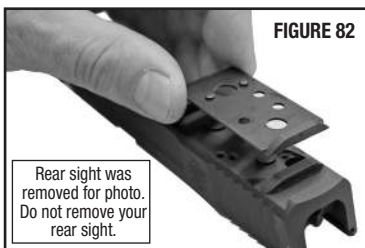

Step 3: Place your optical sight over the spacer plate as shown (FIGURE 83).

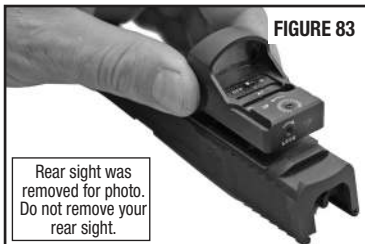

Step 4: Using the appropriate screws (see table on pages 44-45 for details), tighten the sight down onto the slide adapter (FIGURES 84 and 85) using a 5/64" hex wrench.











**WARNING: A SIGHT WHICH IS NOT MOUNTED SECURELY MAY BECOME DETACHED UPON RECOIL OF THE FIREARM. IF IT BECOMES DETACHED IT MAY FLY BACK AND STRIKE THE SHOOTER OR A BYSTANDER AND CAUSE INJURY. OBSERVE THE CONDITION OF THE MOUNTING SCREWS BEFORE AND AFTER FIRING. IF THE MOUNTING SCREWS SHOW SIGNS OF BEING LOOSE BEFORE FIRING OR LOOSENING UPON FIRING DO NOT FIRE THE PISTOL. UNLOAD THE PISTOL AND TIGHTEN THE SCREWS; IF THE SCREWS WILL NOT TIGHTEN CALL THE CUSTOMER SERVICE DEPARTMENT FOR ASSISTANCE AT 1-800-331-0852, EXT. 4125.**

**NOTE:** Follow the instructions provided with your specific sight for the correct mounting and use of that sight.





**WARNING: WHEN INSTALLING AN OPTICAL SIGHT YOU MUST USE THE APPROPRIATE SCREWS FOR YOUR SPECIFIC OPTICAL SIGHT. USE OF IMPROPER SCREWS MAY RESULT IN INJURY TO THE SHOOTER OR BYSTANDERS AND DAMAGE TO PROPERTY.**

**C.O.R.E.™ MOUNTING INSTRUCTIONS CONTINUED**  
**For Use On M&P® M2.0™ C.O.R.E.™ Pistols Only**

<b>M&amp;P® M2.0™ C.O.R.E.™ mounting plate and screw matrix</b>			
<b>Mounting Plate TYPE #</b>	<b># marked on the plate</b>	<b>Use the #6-32 screws supplied by Trijicon</b>	<b>SCREW TYPE A</b> 
	Plate Type <b>#1</b>	TRIJICON® RMR	
	Plate Type <b>#2</b>		
	Plate Type <b>#3</b>		
	Plate Type <b>#4</b>		C-MORE® STS
	Plate Type <b>#5</b>		
	Plate Type <b>#6</b> only comes with guns chambered in 9mm		
	Plate Type <b>#6A</b> only comes with guns chambered in 40 S&W, 10mm & 45 Auto		
	Plate Type <b>#7</b>		

**C.O.R.E.™ MOUNTING INSTRUCTIONS CONTINUED**  
**For Use On M&P® M2.0™ C.O.R.E.™ Pistols Only**

**to match parts to your specific optical sight**

	SCREW TYPE <b>B</b>	SCREW TYPE <b>C</b>	SCREW TYPE <b>D</b>	SCREW TYPE <b>E</b> Only provided with 9mm guns
				
	LEUPOLD® DELTA POINT		J-POINT™ CRIMSON TRACE® 1500	
		DOCTER®		
		INSIGHT™ MRDS		
				LEUPOLD® DELTA POINT PRO Use on 9mm Pistols ONLY
	<p>LEUPOLD® DELTA POINT PRO - Use on 40 S&amp;W, 10mm Auto and 45 Auto. Use the screws from the slide cutout cover plate (shown here) to secure Plate 6A to the slide. Then use the M4x0.7 screws supplied by Leupold to secure the DELTA POINT optic to the plate itself.</p>			
	NIKON® SPUR			

## TRIGGER OVER-TRAVEL SCREW

### On Those M&P® M2.0™ Pistols So-Equipped

- Trigger over-travel is the distance that the trigger travels (when pulled) from the time the striker releases until trigger travel is stopped by contact of the trigger with the over-travel screw in the M&P® M2.0™ pistol's frame (FIGURE 86).



**WARNING: DO NOT ADD PARTS TO OR REPLACE ANY PARTS ON YOUR FIREARM UNLESS THEY ARE GENUINE SMITH & WESSON® PARTS AND YOU FOLLOW THE INSTRUCTIONS SUPPLIED. IF YOU DO OTHERWISE, IMPROPER FUNCTIONING MAY OCCUR AND SERIOUS INJURY OR DEATH MAY RESULT. IN ADDITION TO THE DANGERS PRESENTED, THE USE OF NON-FACTORY PARTS, INCLUDING BUT NOT LIMITED TO GRIPS, BARRELS AND SPRINGS VOIDS ALL WARRANTIES.**

**WARNING: ALWAYS KEEP THE MUZZLE POINTED IN A SAFE DIRECTION.**

**WARNING: ANY TIME YOU HANDLE AN M&P® M2.0™ PISTOL, REMOVE THE MAGAZINE AND OPEN THE SLIDE TO ENSURE THAT IT IS UNLOADED.**

**WARNING: NEVER RELY ON MECHANICAL FEATURES ALONE. ONLY YOUR SAFE GUN HANDLING WILL ENSURE THE SAFE USE OF YOUR FIREARM. THIS IS YOUR RESPONSIBILITY.**

**WARNING: NEVER DISASSEMBLE YOUR HANDGUN BEYOND THE FIELD STRIPPING PROCEDURES OUTLINED IN THIS MANUAL. NEVER MANIPULATE ANY INTERNAL COMPONENTS BEYOND WHAT YOU ARE SPECIFICALLY INSTRUCTED TO DO IN THIS MANUAL SINCE THIS MAY AFFECT THE RELIABILITY, FUNCTIONING AND SAFETY OF YOUR HANDGUN.**

## OVER-TRAVEL ADJUSTMENT SCREW CONTINUED

- Ensure that the pistol is unloaded. To do this, grasp the pistol with your finger off the trigger and outside the trigger guard, point the muzzle in a safe direction, depress the magazine release and remove the magazine (FIGURE 87).
- Point the muzzle in a safe direction, grasp the serrated sides of the slide from the rear with the thumb and fingers as shown (FIGURE 88), and briskly draw the slide fully rearward in order to extract any cartridge from the chamber and clear it from the pistol. Verify that the chamber is empty (FIGURE 89), then release the slide.
- You will need to remove the back strap to gain access to the hole in the frame that allows you to insert the hex wrench to adjust trigger overtravel.
- Remove the frame tool from the bottom of the grip by rotating it 1/4 turn (either direction) and pulling it down - out of the grip frame (FIGURE 90).
- Take the back strap off the handgun by tipping it away from the frame as shown (FIGURE 91).



## OVER-TRAVEL ADJUSTMENT SCREW CONTINUED

- Insert the supplied 1/16" hex wrench thru the hole in the back of the grip (FIGURES 92 and 93) into the adjustment screw (FIGURE 94).

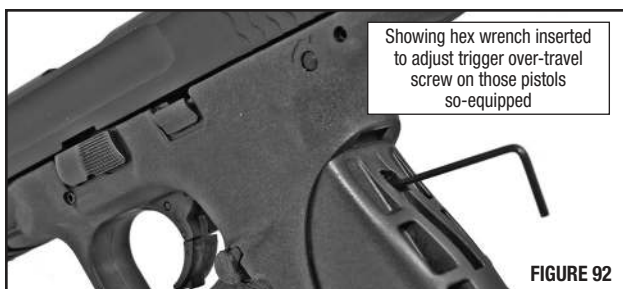

- Turn the over-travel adjustment screw clockwise (as viewed from the rear (breech end) of the pistol). Turn the screw in just far enough so that you cannot pull the trigger and make the striker release. There will be a tactile and audible "click" when the striker releases.

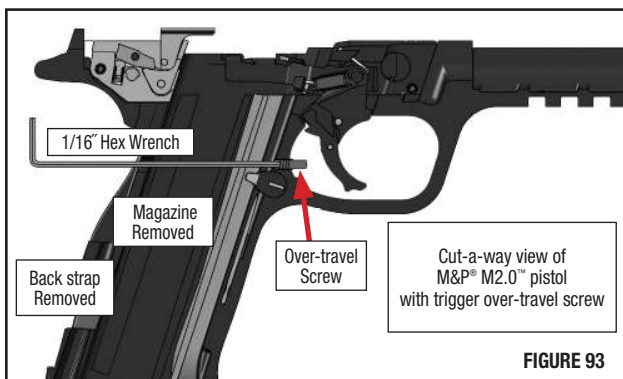

**NOTE:** Rack the slide to reset the striker if the striker falls as you are adjusting the overtravel screw.

- With the trigger pulled (and held) back against the overtravel adjustment screw, turn the screw counter-clockwise (as viewed from the rear of the pistol) until the striker releases. There will be a tactile and audible "click" when the striker releases, then turn the adjustment screw one more full turn counter-clockwise. This is the correct, final position for the over-travel screw.

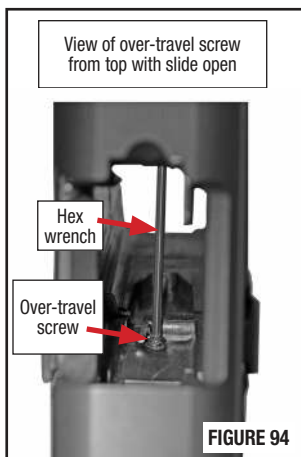

- Do not back the screw out past the one full rotation point as the screw will then be in the way of the magazine release.



## OVER-TRAVEL ADJUSTMENT SCREW CONTINUED

- Replace the back strap and secure it in position by replacing the frame tool.
- Replace the magazine into the pistol.
- Check the unloaded pistol for proper functioning.
- If you have any questions about the over-travel adjustment screw on your M&P® M2.0™ pistol, contact the Customer Service Department at 1-800-331-0852, ext. 4125.

## PORTED BARREL WARNINGS

### On Those M&P® M2.0™ Pistols So-Equipped



**WARNING: ALWAYS KEEP YOUR FACE, HANDS, FINGERS, OR ANY OTHER BODY PARTS AWAY FROM THE BARREL/SLIDE PORTS DURING FIRING. ALWAYS ENSURE THAT BYSTANDERS ARE AWAY FROM THE BARREL/SLIDE PORTS DURING FIRING. PARTICLES AND HOT GAS WILL BE FORCED OUT OF THE BARREL/SLIDE PORTS DURING NORMAL USE. FAILURE TO FOLLOW THIS WARNING WILL CAUSE SERIOUS PERSONAL INJURY AND MAY ALSO RESULT IN DAMAGE TO PROPERTY (CLOTHING, ETC.).**

- **NEVER CYCLE THE SLIDE WITH YOUR HAND OVER THE PORTS.**
- **DO NOT SHOOT A PISTOL WITH A PORTED BARREL “FROM THE HIP” OR FROM A RETENTION POSITION (WHEN THE FIREARM IS IN CLOSE PROXIMITY TO ANY PART OF THE BODY).**
- **USE CAUTION WHEN SHOOTING TO AVOID ANY OBJECTS IN PROXIMITY (OVERHEAD AND TO THE SIDES) THAT COULD BE DAMAGED BY THE PARTICLES AND HOT GAS FORCED FROM THE BARREL/SLIDE PORTS DURING FIRING.**



**WARNING: NEVER INSTALL A PORTED BARREL IN A PISTOL WITH A NON-PORTED SLIDE. FAILURE TO FOLLOW THIS WARNING WILL CAUSE SERIOUS PERSONAL INJURY AND DAMAGE TO PROPERTY.**

## BATTERY WARNINGS



**WARNING: IF A BATTERY OPERATED ACCESSORY OR ATTACHMENT (I.E. LASER, OPTICAL SIGHT OR FLASHLIGHT, ETC.) IS SUPPLIED OR USED WITH THIS FIREARM, THE FOLLOWING WARNINGS AND INSTRUCTIONS MUST BE ADHERED TO.**



**WARNING: KEEP BATTERIES AWAY FROM CHILDREN. THERE IS A CHEMICAL BURN HAZARD ASSOCIATED WITH BATTERIES.**



**WARNING: IF A NEW OR USED LITHIUM BUTTON/COIN CELL BATTERY IS SWALLOWED OR ENTERS THE BODY, IT CAN CAUSE SEVERE INTERNAL BURNS AND CAN LEAD TO DEATH IN AS LITTLE AS 2 HOURS. ALWAYS COMPLETELY SECURE THE BATTERY COMPARTMENT. IF THE BATTERY COMPARTMENT DOES NOT CLOSE SECURELY, STOP USING THE PRODUCT, REMOVE THE BATTERIES, AND KEEP IT AWAY FROM CHILDREN. IF YOU THINK BATTERIES MIGHT HAVE BEEN SWALLOWED OR PLACED INSIDE ANY PART OF THE BODY, SEEK IMMEDIATE MEDICAL ATTENTION.**

- When used correctly, batteries provide a safe and dependable source of portable power. However, misuse or abuse may result in leakage, fire, or explosion.
- Batteries can explode or leak and cause burns if installed backwards, disassembled, charged, or exposed to water, fire or high temperature.
- Always take care to install your batteries correctly observing the “+” and “-” marks on the battery and the device.
- Always replace the whole set of batteries at one time, taking care not to mix old and new batteries, or batteries of different types.
- Store unused batteries in their original packaging and away from metal objects that may short-circuit them.
- Remove discharged batteries from equipment promptly to avoid possible damage from leakage.
- Never dispose of batteries in fire. (Failure to observe this precaution may result in an explosion.)
- The batteries are supplied in a charged state and are not designed for recharging. Recharging may cause leakage, fire, or explosion.
- The batteries should be disposed of properly, including keeping them away from children.
- Dispose of used batteries immediately. Even used batteries may cause injury.

## PATENT INFORMATION

- This product may be covered by one or more patents. Visit [www.smith-wesson.com](http://www.smith-wesson.com) for virtual patent information.

This handgun is not equipped with a device that fully blocks use by unauthorized users. More than 200,000 firearms like this one are stolen from their owners every year in the United States. In addition, there are more than a thousand suicides each year by younger children and teenagers who get access to firearms. Hundreds more die from accidental discharge. It is likely that many more children sustain serious wounds or inflict such wounds accidentally on others. In order to limit the chance of such misuse, it is imperative that you keep this firearm locked in a secure place and take other steps necessary to limit the possibility of theft or accident. Failure to take reasonable preventative steps may result in innocent lives being lost, and in some circumstances may result in your liability for these deaths.

The certification below is required only for handguns sold in the United States with a barrel length shorter than 3".

Smith & Wesson Inc. hereby certifies average accuracy test results for all new handguns with a barrel shorter than 3" as follows:

7 yards	14 yards	21 yards
1.7"	3.9"	6.3"

This certification is based on tests conducted by Smith & Wesson Inc. using a fixed handgun rest and firing ammunition manufactured by a member of the Shooting Arms and Ammunition Manufacturers Institute (SAAMI) as defined in ANSI/SAAMI Z299.3-1993.

This certification represents actual tests based on several handguns, selected at random. Your particular handgun may have accuracy better than the results stated in this certification.

## CUSTOM SERVICE

- We understand that Smith & Wesson gun owners may want to enhance their guns with custom gunsmithing, refinishing or accessories. Our gunsmiths offer specialized services and exclusive products to enhance your shooting experience.
- Accessories for your Smith & Wesson® firearm are available from your local Smith & Wesson Stocking Dealer, or directly from Smith & Wesson.
- Contact the Customer Service Department at 1-800-331-0852, ext. 4125 for information about these services.
- When ordering directly from the factory, please provide the following information:
  - Model Number
  - Dash Number (if applicable)
  - Serial Number
  - Approximate date of purchase
  - Your Complete Return Address
  - VISA/Discover/MasterCard Number and Expiration Date
  - For Foreign Orders Only, Fax Number or E-mail Address

## INTERNATIONAL WARRANTY CENTERS For Owners Outside The United States

**NOTE:** Addresses and contact information for International Warranty Centers is available on the Smith & Wesson website at [www.smith-wesson.com](http://www.smith-wesson.com) or by calling Customer Service toll-free at 1-800-331-0852 ext 4125.



**Smith & Wesson®**

EMPOWERING AMERICANS™



3006363

**Smith & Wesson®**

2100 Roosevelt Avenue • Springfield, MA 01104

[www.smith-wesson.com](http://www.smith-wesson.com)

p/n 3006363

REV:M&P\_M2.0\_PISTOL\_093021