



Smith & Wesson®

SAFETY & INSTRUCTION MANUAL

Model
S&W® 500
Revolvers



Performance Center® Revolvers Included!

Model
S&W® 460
Revolvers



X-Frame Revolvers Only

There are separate manuals for S&W® (J, K, L and N Frame) revolvers and the BODYGUARD® 38 - these manuals are available free upon request or via download from our web site.



**Read the instructions and
warnings in this manual
CAREFULLY BEFORE
using this firearm.**

2100 Roosevelt Avenue • Springfield, MA 01104
1-800-331-0852 • Fax: 413-747-3317
www.smith-wesson.com

Copyright © 2019 Smith & Wesson Inc.
All rights reserved.



**WARNING:
READ THESE**



**INSTRUCTIONS AND WARNINGS
CAREFULLY. BE SURE YOU
UNDERSTAND THESE INSTRUCTIONS
AND WARNINGS BEFORE USING THIS
FIREARM. FAILURE TO READ THESE
INSTRUCTIONS AND TO FOLLOW
THESE WARNINGS MAY RESULT IN
SERIOUS INJURY OR DEATH TO
YOU AND OTHERS AND DAMAGE
TO PROPERTY.**

**THIS SAFETY & INSTRUCTION
MANUAL SHOULD ALWAYS
ACCOMPANY THIS FIREARM AND
BE TRANSFERRED WITH IT UPON
CHANGE OF OWNERSHIP OR WHEN
PRESENTED TO ANOTHER PERSON.**

**A COPY OF THE
SAFETY & INSTRUCTION
MANUAL IS AVAILABLE FREE
VIA DOWNLOAD AT
WWW.SMITH-WESSON.COM
OR UPON REQUEST FROM:**

**SMITH & WESSON®
CUSTOMER SUPPORT CENTER
2100 ROOSEVELT AVENUE
SPRINGFIELD, MA 01104
TEL.: 1-800-331-0852, ext. 4125
E-mail: qa@smith-wesson.com**

TABLE OF CONTENTS

YOUR SAFETY RESPONSIBILITIES	3-6
SAFE STORAGE AND TRANSPORTATION	7-8
AMMUNITION.....	9-11
MODEL AND FEATURES IDENTIFICATION	12
INSPECTING YOUR REVOLVER.....	13
INSPECTING 460 S&W & 500 S&W FORCING CONE	14
INTERNAL LOCK MECHANISM.....	15-17
PREPARATION FOR FIRING	17-18
LOADING.....	18-19
FIRING.....	19-21
DECOCKING	22-23
CLEARING MISFIRES	23
UNLOADING.....	23-24
SIGHT ADJUSTMENT	24
GUNSMITH ADVISORY	25
REMOVABLE COMPENSATOR.....	26-27
CLEANING AND MAINTENANCE.....	28-30
LIMITED WARRANTY	31-32
CONTACT AND SHIPPING INFORMATION	33-34
CUSTOM SERVICE	35
PORTED BARREL WARNING (If so-equipped)	37
INTERNATIONAL WARRANTY CENTERS, PATENT INFO	38
BATTERY WARNINGS.....	39

YOUR SAFETY RESPONSIBILITIES

SAFETY IS YOUR NUMBER ONE RESPONSIBILITY!

- At home, in the field, at the range, or anywhere, the first concern of every firearm owner should be safety. Apply the following safety rules in every situation, with any kind of firearm. If you feel uncertain about any operational aspects of your firearm, please contact Smith & Wesson at 1-800-331-0852, ext. 4125 before proceeding with its operation.
- If you are unfamiliar with firearms you should seek formal training before using your pistol.



WARNING: YOU MUST FOLLOW ALL OF THESE SAFETY RULES TO ENSURE THE SAFE USE OF YOUR FIREARM. THE FAILURE TO FOLLOW THE INSTRUCTIONS AND WARNINGS IN THIS MANUAL COULD CAUSE SERIOUS PERSONAL INJURY OR DEATH TO YOU OR OTHERS AND DAMAGE TO PROPERTY.

- As a firearm owner, you accept a demanding responsibility. How seriously you take this responsibility can be the difference between life and death. There is no excuse for careless or abusive handling of your firearm. At all times handle your firearm with intense respect for its power and potential danger.

YOUR SAFETY RESPONSIBILITIES CONTINUED

- **ALWAYS KEEP YOUR FIREARM POINTED IN A SAFE DIRECTION.** Never point a firearm at anyone or anything you do not intend to shoot whether or not it is loaded. This is particularly important when loading, unloading, or field stripping the gun. ALWAYS control the direction of the firearm.
- **ALWAYS TREAT EVERY FIREARM AS IF IT IS LOADED AND WILL FIRE.** Do not take anyone's word that the firearm is unloaded – always check for yourself. Never pass your firearm to another person until the cylinder or action is open and you visually check that it is unloaded. Keep your firearm unloaded and safely stored when not in use.
- **NEVER PLACE YOUR FINGER INSIDE THE TRIGGER GUARD OR ON THE TRIGGER UNLESS YOU INTEND TO FIRE.** Ensure that other objects do not touch the trigger.
- **ALWAYS BE SURE OF YOUR TARGET AND WHAT IS BEYOND IT.** Always be sure of where the bullet will strike and shoot only where there is a safe backstop free of obstructions, water or other surfaces which can cause ricochets. Be sure your bullet will stop behind your target. Bullets can glance off many surfaces like rocks or the surface of water and travel in unpredictable directions with considerable velocity. Do not fire randomly into the sky.
- **NEVER CROSS OBSTACLES SUCH AS FENCES OR STREAMS WITH A LOADED FIREARM.** Always make certain your firearm is unloaded before crossing a fence, climbing a tree, jumping a ditch or negotiating other obstacles.
- **SAFE GUN HANDLING IS YOUR PERSONAL RESPONSIBILITY AT ALL TIMES.** Firearms are dangerous and can cause serious injury or death if they are misused or used inappropriately. Safety must be the prime consideration of any one who owns or handles firearms. Accidents are the result of violating the rules of safe gun handling and common sense. Firearm safety training is available. Contact your firearms dealer, law enforcement agency, local sportsman's club, etc. for availability.
- **YOU ARE RESPONSIBLE FOR THE FIREARM AT ALL TIMES.** In owning a firearm, you must undertake full-time responsibility for your firearm's safety and security. You must protect yourself and all others against injury or death from misuse of the firearm 24 hours a day.
- **FIREARM SECURITY IS YOUR RESPONSIBILITY.** You must secure firearms safely from children and/or unauthorized users. Your firearm should always be kept unloaded and locked when not in use. A lock has been provided for this purpose. Never assume that the use of this lock is sufficient to safely secure your firearm. You must always evaluate your personal situation and employ the security systems that meet your needs and prevent children and unauthorized users from gaining access to your firearm.

YOUR SAFETY RESPONSIBILITIES CONTINUED

- **APPROPRIATE USE FOR YOUR FIREARM MEANS USING YOUR FIREARM FOR LEGAL PURPOSES.** For example - target shooting, hunting and lawful resistance of deadly criminal force. It is your responsibility to ensure that you are in compliance with all applicable laws and ordinances regarding the use of your firearm.
- **NEVER RELY ON MECHANICAL FEATURES ALONE.** Only your safe gun-handling habits will ensure the safe use of your firearm. This is your responsibility.
- **ALWAYS SAFELY STORE AND SECURE YOUR FIREARM.** Safe and secure storage of your firearm is one of your most important responsibilities. It is a full-time responsibility. You must always secure your firearm and ammunition separately so that they are not accessible to children and/or other unauthorized persons.
- **NEVER KEEP AMMUNITION IN THE SAME LOCATION AS THE FIREARM.** Store each in a separate and secure place.
- **ALWAYS WEAR EYE PROTECTION THAT IS SPECIFIED FOR USE WITH FIREARMS** every time you handle your firearm for cleaning and maintenance.
- **ALWAYS WEAR EYE AND HEARING PROTECTION THAT ARE SPECIFIED FOR USE WITH FIREARMS** every time you discharge your firearm. Make sure others in the vicinity of where you will be shooting do so as well.
- **NEVER USE ALCOHOL OR DRUGS BEFORE OR WHILE SHOOTING.** Do not use your firearm if you are on any medication which impairs, even slightly, your mental or physical ability.
- **ALWAYS HAVE ADEQUATE VENTILATION.** Discharging firearms in poorly ventilated areas, cleaning firearms, or handling ammunition may result in exposure to lead and other substances known to cause birth defects, reproductive harm, and other serious physical injury. Review the warnings and labels for all ammunition and cleaning products carefully. Wash hands thoroughly after exposure.
- **BEFORE HANDLING ANY FIREARM, UNDERSTAND ITS OPERATION.** Not all firearms are the same. Familiarize yourself with the mechanical features of any firearm you intend to use. If you feel uncertain about any operational aspects of your firearm, please contact Smith & Wesson at 1-800-331-0852, ext. 4125 before proceeding with its operation.
- **NEVER ALLOW A FIREARM TO BE USED BY INDIVIDUALS WHO DO NOT UNDERSTAND ITS SAFE OPERATION OR HAVE NOT READ THESE FIREARM SAFETY RULES.**

YOUR SAFETY RESPONSIBILITIES CONTINUED

- **ALWAYS USE THE CORRECT AMMUNITION FOR YOUR PARTICULAR FIREARM** as indicated by the marking on the firearm. Never use non-standard, damaged, corroded or reloaded, (handloaded) ammunition which has not been subjected to internal ballistic pressure testing.
- **BEWARE OF BARREL OBSTRUCTIONS** Be sure the barrel is clear of obstructions before shooting. Mud, water, snow or other objects may inadvertently lodge in the barrel bore. A small obstruction can cause a dangerous increase in pressure and may damage your gun and cause injury to yourself and others.
- **BE SURE ALL ACCESSORIES, SUCH AS HOLSTERS, GRIPS, SLINGS, SCOPES AND OTHER ACCESSORIES ARE COMPATIBLE** with the firearm and that the accessories do not interfere with safe operation. It is your responsibility to understand and follow all of the instructions in this manual, as well as those which may be supplied with your ammunition and any accessory.
- **NEVER DISASSEMBLE YOUR FIREARM** beyond the field stripping procedure outlined in this manual. Improper disassembly or reassembly of your firearm may be dangerous and can lead to serious injury or death.
- **NEVER MANIPULATE, ADJUST OR CHANGE ANY OF THE INTERNAL COMPONENTS OF YOUR FIREARM UNLESS SPECIFICALLY INSTRUCTED TO DO SO IN THIS MANUAL.** Improper manipulation of any other internal component may affect the safety and reliability of your firearm and may cause serious injury or death.
- **NEVER ALLOW ANY ALTERATION OR REPLACEMENT OF PARTS IN YOUR SMITH & WESSON FIREARM UNLESS PERFORMED BY A QUALIFIED GUNSMITH** using genuine Smith & Wesson parts. If you do otherwise, improper functioning of your firearm may occur and serious injury or death and damage to property may result.



WARNING: SAFE USE OF A FIREARM IS YOUR PERSONAL RESPONSIBILITY AND THE FAILURE TO FOLLOW ALL OF THESE BASIC SAFETY RULES MAY RESULT IN SEVERE PERSONAL INJURY OR DEATH TO YOU OR OTHERS AND DAMAGE TO PROPERTY. YOU ARE THE MOST IMPORTANT SAFETY DEVICE WHEN IT COMES TO THE USE OF YOUR FIREARM AND SMITH & WESSON WILL NOT BE RESPONSIBLE FOR ANY PERSONAL INJURY, DEATH OR PROPERTY DAMAGE THAT RESULTS FROM: (1) THE CRIMINAL OR NEGLIGENT USE OF THIS FIREARM; (2) A DISREGARD OF THESE SAFETY INSTRUCTIONS AND WARNINGS; (3) IMPROPER OR CARELESS HANDLING OF THIS FIREARM; (4) THE USE OF NON-STANDARD, DEFECTIVE OR IMPROPER AMMUNITION OR; (5) IMPROPER OR NEGLIGENT MODIFICATIONS OR REPAIRS TO THE FIREARM.

SAFE STORAGE AND TRANSPORTATION



WARNING: ALWAYS POINT THE MUZZLE IN A SAFE DIRECTION.



WARNING: FIREARMS ARE DANGEROUS WHEN USED AND STORED IMPROPERLY. THEY POSE A RISK OF SERIOUS OR FATAL INJURIES. FIREARMS CAN BE ESPECIALLY DANGEROUS TO CHILDREN WHEN THEY ARE STORED IN AN IRRESPONSIBLE AND UNSAFE MANNER. FOR YOUR SAFETY AND THE SAFETY OF OTHERS, IT IS IMPERATIVE THAT YOU KEEP YOUR FIREARM LOCKED AND UNLOADED IN A SECURE PLACE. THE AMMUNITION SHOULD BE STORED IN A SEPARATE, SECURE LOCATION WHEN IT IS NOT IN USE. SAFE AND SECURE STORAGE OF YOUR FIREARM IS ONE OF THE MOST IMPORTANT RULES OF FIREARM SAFETY. YOUR FAILURE TO FOLLOW THESE RULES MAY RESULT IN SERIOUS INJURY OR DEATH TO YOU OR OTHERS.

- **ALWAYS SECURE YOUR FIREARM IN A MANNER THAT WILL PREVENT UNAUTHORIZED ACCESS.** Whenever your firearm is not in use, keep it unloaded and locked. Your safety and the safety of others requires that you always secure and store your firearm in a manner that will prevent unauthorized access. Never leave a firearm unattended unless it is locked, unloaded and secured.
- **ALWAYS USE THE LOCK PROVIDED BY SMITH & WESSON TO SECURE YOUR FIREARM.** Please read and follow the instructions packaged separately for the use of this lock. A lock, when properly used, can be an effective tool in preventing unauthorized access to your firearm. There are other alternative locks and safe storage containers available in the marketplace which may also be appropriate for your particular needs. Consult your local gun shop, hardware store, or local police department for guidance on the variety of other safe storage devices or practices which may be appropriate for your particular needs. By purchasing this firearm you have accepted the responsibility of safely securing the firearm at all times and preventing its unauthorized use. Never assume that the use of this lock alone is sufficient to safely secure your firearm. It is your personal responsibility to select and use whatever measures or practices that will enable you to be absolutely certain that your firearm is secure at all times.



WARNING: NEVER LOCK A LOADED FIREARM AND NEVER LOAD A LOCKED FIREARM!!

SAFE STORAGE AND TRANSPORTATION CONTINUED

- **ALWAYS STORE YOUR FIREARM AND AMMUNITION SEPARATELY** so that they are not accessible to children or other unauthorized persons. Safe and secure storage of your firearm and ammunition are your responsibility. It is a full-time responsibility.
- **NEVER ASSUME THAT A “HIDING” PLACE IS A SECURE STORAGE METHOD.** Others may be aware of your storage location or come upon it by chance. It is your personal responsibility to use common sense when storing your firearm and ammunition and to always make sure they are not accessible to children or other unauthorized persons.
- **NEVER TRANSPORT A LOADED FIREARM.** When transporting your firearm, be sure it is unloaded and locked. Safe and secure transportation of your firearm is your responsibility.
- **ALWAYS FOLLOW THE LAW!** Many jurisdictions have laws that make it a crime to keep a firearm unlocked and in an area accessible to children or others. Keeping a firearm locked and unloaded when not in use is not only common sense safety practice... IT IS THE LAW. You must be familiar with all local, state, and federal laws regarding the safe storage and transportation of your firearm. Failure to know and follow the law may result in unauthorized access or use of your firearm by another. Obey all laws relating to the storage and transportation of firearms. Your local police department or gun shop can furnish you with available information on storing and/or transporting a firearm safely and legally.
- **YOUR FIREARM IS YOUR RESPONSIBILITY.** You must prevent your firearm from being stolen or from being used by untrained or unqualified individuals. Keep it locked, unloaded and secured when not in use.

AMMUNITION



WARNING: NEVER USE AMMUNITION NOT SPECIFICALLY DESIGNATED FOR USE IN YOUR FIREARM. FAILURE TO USE THE CORRECT TYPE OR CALIBER OF AMMUNITION MAY CAUSE THE FIREARM TO JAM, FAIL TO FIRE OR EVEN GENERATE EXCESSIVE PRESSURE WHICH CAN DAMAGE OR EVEN RUPTURE YOUR FIREARM, CAUSING PERSONAL INJURY, DEATH OR PROPERTY DAMAGE.

- You are responsible for selecting ammunition that meets industry standards and is appropriate in type and caliber for this firearm.
- Never use a cartridge not specifically designated for use in your firearm. The wrong type of ammunition may exceed the capability of your firearm and may damage or even rupture your firearm.
- Never mix ammunition.
- Locate the cartridge designation marked on the firearm.



This information indicates the correct ammunition that must be used in this firearm (FIGURE 1).



WARNING: IN SOME CASES, A ROUND OF AMMUNITION NOT SPECIFIED ON YOUR FIREARM AND NOT LISTED AS ALTERNATE AMMUNITION IN THIS MANUAL, MAY FIT INTO THE CHAMBER. FIRING THIS AMMUNITION MAY CAUSE A RUPTURE RESULTING IN DAMAGE TO THE FIREARM AND PERSONAL INJURY OR DEATH TO THE SHOOTER OR BYSTANDERS. FOR MORE INFORMATION REGARDING UNSAFE CALIBER COMBINATIONS, REFER TO THE FOLLOWING URL: [HTTPS://SAAMI.ORG/TECHNICAL-INFORMATION/UNSAFE-FIREARM-AMMUNITION-COMBINATIONS/](https://saami.org/technical-information/unsafe-firearm-ammunition-combinations/)



WARNING: ALWAYS INSPECT YOUR AMMUNITION BEFORE USING IT. NEVER USE DIRTY, CORRODED OR DAMAGED AMMUNITION. A BORE OBSTRUCTION OR BURST CARTRIDGE MAY RESULT, CAUSING DAMAGE TO THE FIREARM AND PERSONAL INJURY OR DEATH TO THE SHOOTER OR BYSTANDERS.

ALTERNATE AMMUNITION: Select cartridges can be used in firearms so marked from the following list:

Caliber Marked on Barrel

500 S&W MAGNUM
460 S&W MAGNUM

Can also Fire

500 Special
454 Casull, 45 Colt

AMMUNITION CONTINUED

- Use only commercially manufactured ammunition with internal ballistic pressures which are in strict accordance with the specifications of the Sporting Arms and Ammunition Manufacturers' Institute (SAAMI). If you are uncertain, contact your ammunition supplier for verification.



WARNING: NEVER USE NON-STANDARD, RELOADED OR "HANDLOADED" AMMUNITION WHICH HAS NOT BEEN SUBJECTED TO INTERNAL BALLISTIC PRESSURE TESTING. RELOADED OR HANDLOADED AMMUNITION, MAY HAVE MANY MANUFACTURING AND QUALITY VARIABLES (SUCH AS THE TYPE AND AMOUNT OF GUN POWDER). CARTRIDGE CASES THAT HAVE BEEN RELOADED AND FIRED MULTIPLE TIMES MAY SUFFER PHYSICAL DAMAGE WHICH COULD SIGNIFICANTLY IMPACT OR REDUCE THE INTEGRITY OF THE CARTRIDGE, POSSIBLY RESULTING IN BULLET SET-BACK OR UNSEATING. CASE FAILURE AND INJURY TO THE SHOOTER OR BYSTANDERS AND DAMAGE TO THE FIREARM MAY RESULT WHEN SUCH A ROUND IS FIRED. ANY AMMUNITION THAT IS IMPROPERLY MANUFACTURED OR RELOADED, EVEN IN THE SLIGHTEST DEGREE, MAY FAIL TO FIRE OR MAY GENERATE EXCESSIVE INTERNAL PRESSURES WHICH CAN DAMAGE OR EVEN RUPTURE THE FIREARM, CAUSING PERSONAL INJURY OR DEATH TO THE SHOOTER OR THOSE IN THE IMMEDIATE VICINITY.

- A firearm and ammunition are a system and must work together. There are different types of ammunition for different types of firearms. Your firearm has been designed for ammunition of a specific type and a specific gauge or caliber. It is important to select the proper ammunition for your firearm.
- Different combinations of bullet velocity, bullet weight and firearm weight can have major impact on felt recoil; high felt recoil can be uncomfortable to some shooters.

For example:

- Firearm Weight: lower firearm weight increases felt recoil.
- Bullet Weight: higher bullet weight increases felt recoil.
- Bullet Velocity: higher bullet velocity increases felt recoil.

To acclimate yourself to higher levels of felt recoil, consider the following:

- Use a firm two-hand hold on the grip when firing.
- Always start your shooting experience with the lowest bullet velocity and lowest bullet weight available for your firearm.
- Ask your firearm dealer to suggest the lowest power, lowest velocity, lightest bullet weight for your firearm.

AMMUNITION CONTINUED



WARNING: NEVER USE AMMUNITION OF THE INCORRECT GAUGE OR CALIBER. USING AMMUNITION OF THE INCORRECT GAUGE OR CALIBER MAY CAUSE DAMAGE TO YOUR FIREARM AND POSSIBLE SERIOUS INJURY TO YOU AND TO OTHERS.



WARNING: NEVER USE CARTRIDGES OTHER THAN THOSE DESIGNATED BY THE MARKING ON THE FIREARM. DOING SO CAN RESULT IN DANGEROUSLY HIGH PRESSURES THAT MAY DAMAGE THE FIREARM AND POSSIBLY CAUSE SERIOUS INJURY TO YOURSELF AND OTHERS.



WARNING: DEATH, SERIOUS INJURY AND PROPERTY DAMAGE CAN RESULT FROM THE USE OF INCORRECT AMMUNITION OR BORE OBSTRUCTIONS. NEVER USE RELOADED AMMUNITION THAT HAS NOT BEEN SUBJECTED TO INTERNAL BALLISTIC PRESSURE TESTING. SEE PAGE 10 FOR DETAILS.



WARNING: DISCHARGING FIREARMS IN POORLY VENTILATED AREAS, CLEANING FIREARMS, OR HANDLING AMMUNITION MAY RESULT IN EXPOSURE TO LEAD AND OTHER SUBSTANCES KNOWN TO CAUSE BIRTH DEFECTS, REPRODUCTIVE HARM, AND OTHER SERIOUS PHYSICAL INJURY. HAVE ADEQUATE VENTILATION AT ALL TIMES. WASH HANDS THOROUGHLY AFTER EXPOSURE.

- “Plus-P” (+P) ammunition generates pressures in excess of the pressures associated with standard ammunition. Such pressures may affect the wear characteristics and may result in the need for more frequent service.
- “Plus-P-Plus” (+P+) ammunition must not be used in Smith & Wesson firearms. This marking on the ammunition designates that it exceeds established industry standards, but the designation does not represent defined pressure limits and therefore such ammunition may vary significantly as to the pressures generated and could be DANGEROUS.
- Some brands of ammunition may cause difficulty in extracting spent cartridge cases from the chamber. If this situation occurs, thoroughly clean the chamber with solvent. If this condition persists, we recommend changing to another brand of ammunition.

MODEL AND FEATURES IDENTIFICATION

- The internal serial number and the model number appear inside the yoke (FIGURE 2) when the cylinder is in the open position.

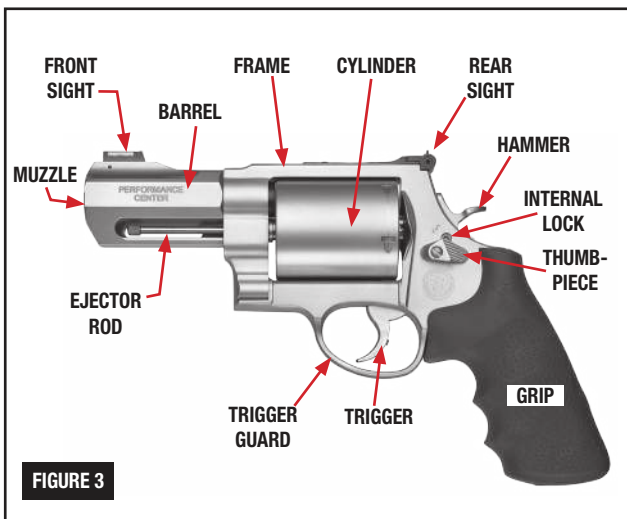
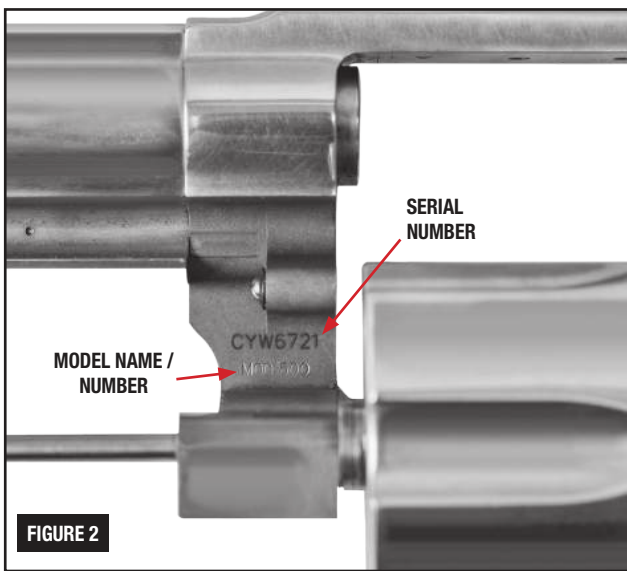

INSPECTING YOUR REVOLVER



WARNING: ALWAYS ENSURE THAT THE FIREARM IS UNLOADED BEFORE INSPECTING, DISASSEMBLING, ASSEMBLING OR CLEANING AND ALWAYS KEEP THE MUZZLE POINTED IN A SAFE DIRECTION.



FIGURE 4

- Check for yourself to ensure that the firearm is unloaded when you inspect your revolver.
- Before using your firearm for the first time, it should be cleaned. See the cleaning section of this manual for details.
- With your finger off the trigger and outside of the trigger guard (FIGURE 5), keep the barrel of the firearm pointed in a safe direction. Press the thumbpiece fully forward and hold it, then push the cylinder to the left (FIGURE 6).

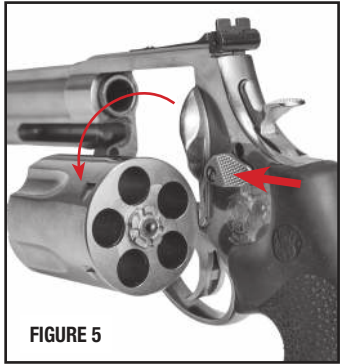

FIGURE 5

- You must verify that all charge holes (chambers) are free of live ammunition and that the bore is free of obstructions.
- Follow this procedure every time the revolver leaves your hand, is cleaned, handed to you or another person, transported or stored.



WARNING: NEVER RELY ON MECHANICAL FEATURES ALONE. ONLY YOUR SAFE GUN HANDLING WILL ENSURE THE SAFE USE OF YOUR FIREARM. THIS IS YOUR RESPONSIBILITY.

INSPECTING THE FORCING CONE OF MODEL SMITH & WESSON® 460 MAGNUM AND 500 MAGNUM REVOLVERS

- Before using a Smith & Wesson 460 S&W® Magnum or 500 S&W® Magnum revolver you should open the cylinder and inspect the barrel forcing cone to ensure that it is in good working order.
- FIGURE 6a shows a forcing cone in good condition. You can continue to use it following safe gun handling techniques detailed in this manual.

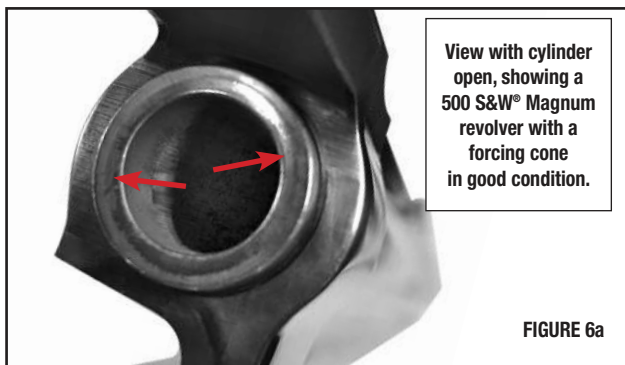

- FIGURE 6b shows a barrel forcing cone that is eroded excessively and needs to be replaced. If your forcing cone looks like the barrel in FIGURE 3c, we will replace the barrel with a new one for a nominal fee. Send the revolver back to Smith & Wesson® for replacement following the directions starting on page 33 of this manual.

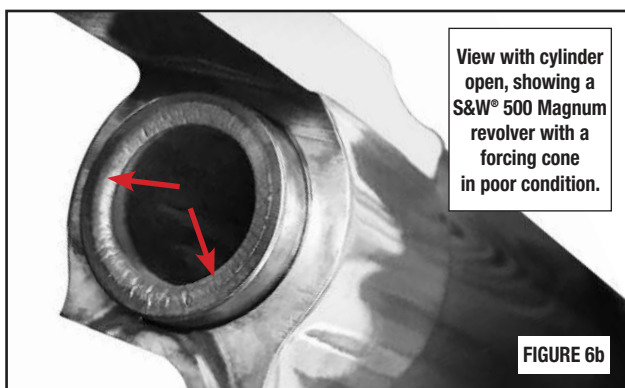

WARNING: A REVOLVER WITH EXCESSIVE FORCING CONE EROSION MAY LEAD TO BARREL FAILURE RESULTING IN INJURY TO THE SHOOTER OR BYSTANDERS AND DAMAGE TO PROPERTY.

INTERNAL LOCK MECHANISM



WARNING: NEVER RELY ON THE INTERNAL LOCK MECHANISM AS THE SOLE METHOD TO SECURE YOUR FIREARM FROM UNAUTHORIZED USE.



WARNING: IT IS YOUR RESPONSIBILITY TO CONTINUOUSLY EXAMINE YOUR PERSONAL SITUATION TO PROVIDE A SUFFICIENT LEVEL OF SECURITY TO KEEP UNAUTHORIZED USERS FROM FIRING THE REVOLVER.

- This feature prevents hammer and trigger motion when locked. On revolvers with internal lock mechanisms, markings on the left side of the frame, adjacent to the lock, indicate the locking direction. In addition, revolvers with fully exposed hammers display a flag marked “LOCKED” when the revolver is locked. This lock requires an external key to engage and to disengage the revolver lock. The lock is located adjacent to and slightly over the thumbpiece (FIGURE 7).

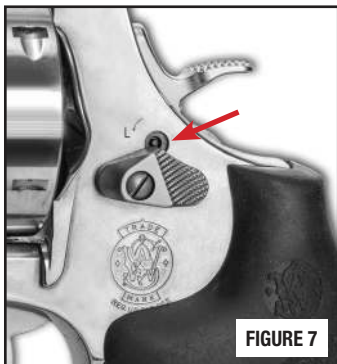

FIGURE 7

TO ENGAGE THE LOCK



WARNING: NEVER LOCK A LOADED HANDGUN, NEVER LOAD A LOCKED HANDGUN AND NEVER LOCK THE HANDGUN WITH THE HAMMER COCKED.

- Open the cylinder and ensure the revolver is completely unloaded.
- Hold the revolver with the cylinder open in one hand. Insert the key and turn it counter-clockwise using the other hand. The key will turn approximately 90 degrees. The locked indicator flag will become visible on revolvers with exposed hammers. A definite stop and detent will be felt when the key is turned to either the locked or the unlocked position (FIGURE 8).

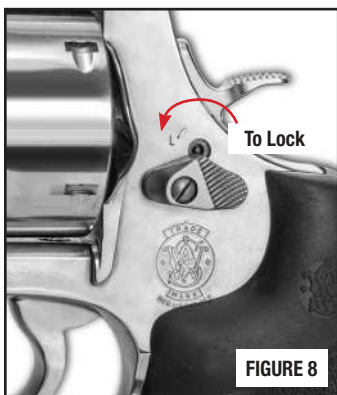

FIGURE 8

INTERNAL LOCK MECHANISM CONTINUED



WARNING: NEVER ATTEMPT TO DETERMINE WHETHER A REVOLVER IS LOCKED OR UNLOCKED BY PULLING THE TRIGGER.

TO DISENGAGE THE LOCK



WARNING: ALWAYS OPEN THE CYLINDER AND VERIFY THE REVOLVER IS UNLOADED AND EACH CHARGE HOLE IS EMPTY BEFORE UNLOCKING THE REVOLVER.

- With the cylinder open, hold the revolver in one hand. Insert the key and turn it approximately 90 degrees in a clockwise direction using the other hand until the flag returns to its hidden, unlocked position on revolvers with exposed hammers. A definite stop and detent will be felt when the key is turned to either the locked or the unlocked position (FIGURE 9).

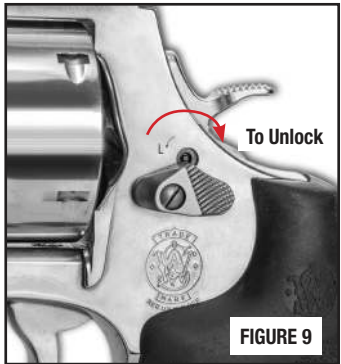

WARNING: ALWAYS RECOVER FROM A SITUATION WHERE THE REVOLVER HAS BEEN INCORRECTLY LOCKED WITH THE HAMMER COCKED BY FOLLOWING THESE STEPS. THROUGHOUT THIS PROCEDURE, YOU MUST TREAT THE REVOLVER AS IF IT IS LOADED.

- 1.) With your finger off of the trigger and outside of the trigger guard, place the thumb of your shooting hand on the hammer and pull fully rearward to ensure the hammer is in the fully cocked position.
 - 2.) With your finger still off of the trigger and outside of the trigger guard and the revolver pointed in a safe direction, unlock the lock using the key provided.
 - 3.) Follow the decocking procedure to decock the revolver. Always assume that the revolver is loaded while following this procedure.
 - 4.) Open the cylinder and verify that the revolver is unloaded.
- The position of the cylinder has no relationship to the locked status of the revolver.
 - When the revolver is properly locked, the cylinder may be opened or closed.

INTERNAL LOCK MECHANISM CONTINUED



WARNING: NEVER ASSUME THAT THE USE OF THIS LOCK IS SUFFICIENT TO SAFELY SECURE YOUR FIREARM. IT IS YOUR PERSONAL RESPONSIBILITY TO SELECT AND USE WHATEVER MEASURES OR PRACTICES THAT WILL ENABLE YOU TO BE ABSOLUTELY CERTAIN THAT YOUR FIREARM IS SECURE AT ALL TIMES.



WARNING: IT IS YOUR RESPONSIBILITY TO ENSURE THAT THE REVOLVER AND AMMUNITION ARE NOT AVAILABLE TO UNAUTHORIZED USERS.



WARNING: NEVER PROVIDE THE KEY OR REVEAL THE LOCATION OF THE KEY TO ANYONE WHO YOU DO NOT INTEND TO USE THIS HANDGUN.

PREPARATION FOR FIRING



WARNING: THE FAILURE TO FOLLOW THESE FIREARM SAFETY REQUIREMENTS WILL CAUSE SERIOUS PERSONAL INJURY OR DEATH TO YOU OR OTHERS.

- **ALWAYS TREAT ALL FIREARMS AS IF THEY ARE LOADED.**
- **ALWAYS BE SURE THAT THE CYLINDER AND ACTIONS OF FIREARMS ARE OPEN, THAT CHAMBERS ARE CLEAR OF CARTRIDGES OR SHELLS, MAGAZINES ARE REMOVED OR UNLOADED, AND THAT FIREARMS ARE POINTING IN A SAFE DIRECTION.**
- **ALWAYS KEEP FINGERS AND OTHER PARTS OF YOUR BODY AWAY FROM THE MUZZLE, AWAY FROM THE GAP BETWEEN THE BARREL AND REVOLVER CYLINDER, AND AWAY FROM ANY BARREL PORTS OR COMPENSATORS ON THE FIREARM WHEN FIRING.** Failure to do so creates a risk of personal injury from bullets, hot gases from burning powder and/or debris spitting.
- **ALWAYS WEAR ADEQUATE AND PROPER HEARING PROTECTION SPECIFIED FOR FIREARM USE** to prevent permanent damage to your hearing. Make sure others who are nearby are wearing hearing protection as well.
- **ALWAYS WEAR SAFETY GLASSES SPECIFIED FOR FIREARM USE**, whether indoors or out. Safety glasses should protect your eyes from the firing flash and particles associated with the discharge of ammunition. Failure to do so creates a risk of personal injury from particle or debris spitting or ricochets.
- **ALWAYS BE ALERT AND ALWAYS FOLLOW THE SAFETY INSTRUCTIONS OF THE RANGE OFFICER.** Never shoot if you are tired, cold or impaired in any way.
- **ALWAYS BE AWARE OF OTHER PEOPLE** so that persons cannot accidentally walk into the line of fire.

PREPARATION FOR FIRING CONTINUED

- **THE SHOOTER (AND ALL OTHERS IN THE SHOOTING AREA) MUST ALWAYS BE IN A POSITION THAT IS OUT OF THE LINE OF FIRE** and are not within an area where they may be struck by a ricochet or particles spitting from a firearm, or by ejected cases from some types of firearms.
- **NEVER SHOOT AT SURFACES THAT MAY CAUSE A RICOCHET.** Always select a place to shoot that has a safe backstop, is free from obstructions and has no surfaces which may cause a ricochet.
- **NEVER FIRE RANDOMLY INTO THE SKY.** Always select a place to shoot that has a safe backstop.
- **NEVER USE ALCOHOL OR DRUGS BEFORE OR WHILE SHOOTING OR HANDLING ANY FIREARM.**

LOADING



WARNING: ALWAYS KEEP THE MUZZLE POINTED IN A SAFE DIRECTION.

- Never load your revolver until you have read and fully understand this manual.
- Do not load the revolver until you are ready to use it. Keep your finger off the trigger and outside the trigger guard until you are ready to fire.
- Never load your revolver until you are at the shooting site and fully prepared to fire.
- If your internal lock is engaged, unlock it before proceeding.
- To load your revolver, hold it in one hand with the muzzle pointed in a safe direction and away from you and others.
- Keep your finger off the trigger and out of the trigger guard.
- Press the thumbpiece forward to unlock the cylinder.
- Push the cylinder to the left and place a round of the correct ammunition in each charge hole.
- Grasp the revolver in the shooting hand with your finger still outside the trigger guard (FIGURE 10).
- Push the cylinder back into the frame until it locks into place.
- Your revolver is now fully loaded. The hammer is in the “at rest” position as shown in FIGURE 10.

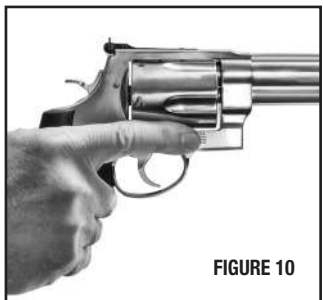

FIGURE 10

LOADING CONTINUED



WARNING: THE REVOLVER WILL FIRE IF THE TRIGGER IS PULLED!



WARNING: ALWAYS INSPECT YOUR REVOLVER VISUALLY TO BE SURE THE HAMMER AND TRIGGER ARE IN THE AT REST OR FORWARD POSITION BEFORE HOLSTERING OR CARRYING IT. NEVER HOLSTER, CARRY OR STORE YOUR REVOLVER WITH THE HAMMER COCKED. REMEMBER TO KEEP YOUR REVOLVER POINTED IN A SAFE DIRECTION. NEVER LEAVE A LOADED FIREARM UNATTENDED.

FIRING



WARNING: ALWAYS KEEP THE MUZZLE POINTED IN A SAFE DIRECTION.



WARNING: WEAR EYE AND HEARING PROTECTION SPECIFIED FOR FIREARM USE EVERY TIME YOU DISCHARGE YOUR FIREARM. MAKE SURE OTHERS IN THE VICINITY OF WHERE YOU WILL BE SHOOTING DO SO AS WELL.



WARNING: ALWAYS KEEP YOUR FINGERS AND OTHER BODY PARTS AWAY FROM THE BARREL/CYLINDER GAP DURING FIRING. PARTICLES AND HOT GAS WILL BE FORCED OUT FROM BETWEEN THE BARREL AND CYLINDER IN ANY REVOLVER DURING NORMAL USE. FAILURE TO FOLLOW THIS WARNING WILL RESULT IN SERIOUS PERSONAL INJURY.



WARNING: SMITH & WESSON X-FRAME REVOLVERS ARE OFFERED IN SEVERAL VERY POWERFUL CHAMBERINGS. THESE CARTRIDGES DEVELOP HEAVY RECOIL WHEN FIRED. THE SHOOTER SHOULD BE PREPARED FOR HEAVY RECOIL AND SHOULD ALWAYS MAINTAIN A SECURE GRIP WHEN FIRING. FAILURE TO CONTROL HEAVY RECOIL CAN RESULT IN PERSONAL INJURY AND/OR PROPERTY DAMAGE UPON FIRING. ANYONE WHO LACKS SUFFICIENT STRENGTH TO CONTROL HEAVY RECOIL SHOULD NOT FIRE THESE REVOLVERS.

FIRING CONTINUED

- Always use the proper grip as shown for a two-hand hold (FIGURES 11 and 12). This keeps hands and fingers away from the barrel/cylinder gap.
- Never allow hands or fingers to extend beyond the front of the cylinder when firing (FIGURES 13 and 14). This is an improper hold for any revolver.

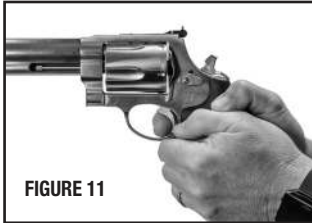

FIGURE 11

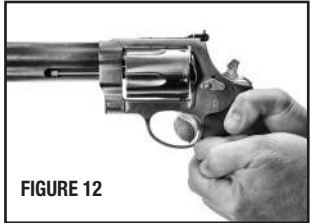

FIGURE 12

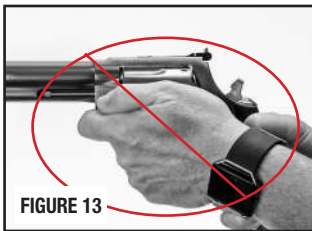

FIGURE 13

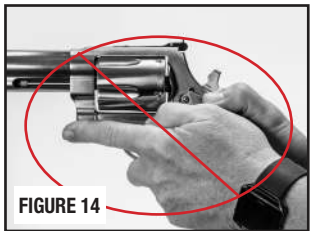

FIGURE 14

- There are two ways to fire your Smith & Wesson revolver. The first is in the double action mode, wherein the shooter fully pulls and holds the trigger to the rear, causing the hammer to fully cycle rearward and then release.
- The second way to fire a revolver is in the single action mode, in which the hammer is first cocked and the trigger is then pulled and held to the rear. A lesser amount of trigger pressure and travel are necessary to fire the revolver when the hammer is in the cocked position. It is your responsibility to exercise great care in handling a revolver especially when it has been placed in the single action or cocked mode.



WARNING: "STAGING" THE TRIGGER (KEEPING TENSION ON THE TRIGGER) VIOLATES A BASIC RULE OF FIREARM SAFETY WHICH WARNS YOU TO KEEP YOUR FINGER OUT OF THE TRIGGER GUARD UNTIL YOU HAVE MADE THE COMMITMENT TO FIRE. "STAGING" CREATES A SERIOUS RISK OF PERSONAL INJURY OR DEATH SINCE IT MAY LEAD TO AN UNINTENTIONAL DISCHARGE.

- It has come to our attention that some users of Smith & Wesson handguns may stage the trigger in anticipation of firing a shot. Staging is the act of pulling the trigger rearward toward — stopping just short of — the point where the hammer falls and the handgun fires. Such manipulation of the trigger can reduce the user's control of the handgun and can result in an unintentional discharge. Furthermore if the user decides not to fire, release of the trigger from a position close to the firing point in the staging process could result in an unintended discharge.

FIRING CONTINUED

DOUBLE ACTION FIRING

- Never touch the trigger until you are ready to fire.
- To fire the handgun, pull the trigger fully to the rear. The hammer will move rearward and then fall forward to fire the revolver. After firing, you must allow the trigger to move forward fully before you can fire another shot. Failure to do so will prevent the lock work from fully cycling and will prevent you from being able to fire the next shot.
- Keep your finger off the trigger and outside the trigger guard until you are ready to fire again. Do not touch or otherwise interfere with the travel of the hammer during double action firing.

SINGLE ACTION FIRING

- Never touch the trigger until you are ready to fire.
- To fire the handgun, place your non-shooting hand on the hammer spur.
- Pull the hammer fully rearward until it is cocked as shown in FIGURE 15. The action of pulling the hammer to the rear until it is cocked will also cause the trigger to move rearward. The revolver will now fire in the single action mode, requiring significantly less trigger pressure and significantly less travel than in the double action mode.



- Pull the trigger and hold it rearward.
- After firing, you must allow the trigger to move fully forward before you can fire another shot. Failure to do so will prevent the lock work from fully cycling and will prevent your being able to fire the next shot. Keep your finger off the trigger and outside the trigger guard until you are ready to fire again.



WARNING: ONLY PLACE THE REVOLVER IN THE SINGLE ACTION MODE WHEN YOU ARE FULLY PREPARED TO FIRE.

DECOCKING

• If you decide not to fire in single action from a cocked position, continue to point the firearm in a safe direction and then decock the revolver as follows:

1.) Place the thumb of your free hand between the hammer and the frame of the handgun to prevent the hammer from moving fully forward until your finger is off the trigger and out of the trigger guard (FIGURE 16).



2.) Place the thumb of your firing hand on the hammer spur. You must always control the hammer with your thumbs when decocking the handgun. If the hammer slips while the trigger is held to the rear and you have failed to block the hammer travel, your handgun will fire (FIGURE 17).



3.) Apply pressure to the trigger to release the hammer as shown (FIGURE 17). Immediately after the hammer has come out of cocked position, release the trigger and withdraw your finger from the trigger guard (FIGURE 18).

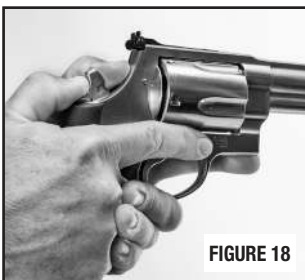

WARNING: FAILURE TO REMOVE YOUR FINGER FROM THE TRIGGER GUARD AS SOON AS THE HAMMER RELEASES COULD CAUSE THE REVOLVER TO FIRE IF YOUR THUMB SLIPS OFF OF THE HAMMER SPUR.

4.) Carefully ease the hammer forward while removing your other thumb from between the hammer and frame (FIGURE 18) until the hammer is in the “at rest” position (FIG 19).

5.) Practice this procedure with your unloaded revolver until you have mastered decocking. Always be aware of the hammer position. Never holster, carry or store a cocked revolver. Be sure the hammer is in the “at rest” position as shown (FIGURE 19) after decocking.



DECOCKING CONTINUED

CAUTION: Incomplete Decocking

Failure to release the trigger and to withdraw your finger from the trigger guard immediately after the hammer has come out of the cocked position may result in the interruption of the forward movement of the hammer between the cocked position and the “at rest” position. In this case, the hammer will appear to have stopped in between the full cock and “at rest” positions. If this occurs, keep your finger off the trigger and out of the trigger guard while returning the hammer with your thumb to the fully cocked position. Then properly decock the hammer to the “at rest” position following the decocking procedures outlined above.

CLEARING MISFIRES



WARNING: IF YOUR HANDGUN GIVES ANY INDICATION THAT IT IS NOT PERFORMING PROPERLY OR THE OPERATION OF YOUR HANDGUN HAS CHANGED “THE WAY IT FEELS OR SOUNDS”, STOP FIRING. MAKE SURE THE FIREARM IS POINTED IN A SAFE DIRECTION, UNLOAD THE FIREARM AND HAVE IT INSPECTED AND TEST-FIRED BY A GUNSMITH QUALIFIED TO PERFORM SERVICE ON SMITH & WESSON FIREARMS.

- If a cartridge fails to fire, wait ten seconds while keeping the muzzle pointed in a safe direction.
- Keep your finger off the trigger and out of the trigger guard.
- Press and hold the thumbpiece forward and swing the cylinder to the left.
- Remove the defective cartridge and dispose of it in a method specifically approved for live round disposal.

UNLOADING



WARNING: ALWAYS KEEP YOUR REVOLVER POINTED IN A SAFE DIRECTION. ALWAYS KEEP YOUR FINGER OFF THE TRIGGER AND OUTSIDE THE TRIGGER GUARD.

- Point the muzzle in a safe direction. Make sure your finger is off the trigger and the trigger is in the “at rest” or forward position.
- To remove either live cartridges or spent casings from the cylinder, first point the barrel in a safe direction. Press the thumbpiece forward and swing and hold the cylinder fully to the left.

UNLOADING CONTINUED

- With the barrel pointing upward in a safe direction, press the extractor rod through the cylinder and remove all cartridges or casings from the cylinder (FIGURE 20).



FIGURE 20

- Carefully count the cartridges or spent casings to be sure that you have recovered all of them.
- Make a visual check to be sure all charge holes (chambers) are empty. When unloading your revolver, always be sure to keep it pointed in a safe direction. Remember, a safe direction means that you are not pointing the barrel of your handgun at yourself or anyone or anything you do not intend to shoot.
- Safely secure and store ammunition separately from your firearm after unloading.
- Be sure to safely secure the firearm when you are finished using it.

SIGHT ADJUSTMENT



WARNING: ENSURE THAT YOUR FIREARM IS UNLOADED BEFORE ADJUSTING THE SIGHTS. ALWAYS FOLLOW THE RULES OF SAFE GUN HANDLING.

- To make a sight adjustment with an adjustable rear sight (reference FIGURE 21);

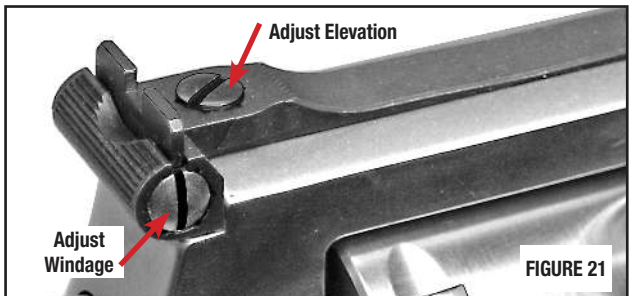

FIGURE 21

- To raise the point of impact, raise the rear sight by turning the elevation screw counterclockwise one or two clicks at a time.
- To lower the point of impact, lower the rear sight by turning the elevation screw clockwise one or two clicks at a time.
- Move the point of impact to the right by turning the windage screw clockwise one or two clicks at a time.
- Move the point of impact to the left by turning the windage screw counterclockwise one or two clicks at a time.

GUNSMITH ADVISORY

FOR USE BY TRAINED GUNSMITHS ONLY

CAUTION: For revolvers with a barrel/barrel shroud design.

- NO attempt should ever be made to remove the hybrid barrel assembly with a standard barrel wrench. To do so will destroy the barrel shroud and possibly the frame of your revolver. As the accompanying drawing (FIGURE 22) shows, the barrel shroud is keyed into the frame by a metal tab. The stainless steel barrel tube must only be removed by a qualified gunsmith using a special tool available from Smith & Wesson. The barrel assembly is re-installed using the same tool and an accurate torque wrench.

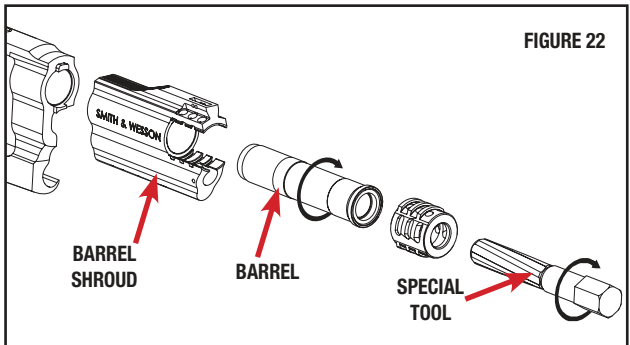

REMOVABLE COMPENSATOR FOR S&W® X-Frame Model Revolvers

FIGURE 23a

With Top Ports

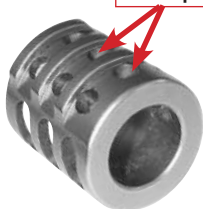

USE WITH JACKETED BULLETS

FIGURE 23b

No Top Ports



USE WITH LEAD BULLETS



WARNING: ENSURE THAT YOUR FIRE-ARM IS UNLOADED BEFORE ATTEMPTING ANY ADJUSTMENT OR COMPENSATOR CHANGE. ALWAYS FOLLOW THE RULES OF SAFE GUN HANDLING.

REMOVAL INSTRUCTIONS

1. Insert a 2.5mm hex wrench into the screw under the compensator, (below the muzzle opening) and turn **CLOCKWISE** until the lock screw stops (approximately 2-3 turns) (FIGURE 24).

2. Rotate the compensator (muzzle brake) with your fingers (or hex wrench if necessary) either left or right for 1/4 turn (FIGURES 25 and 26).

3. Remove the compensator from the barrel for cleaning or for a compensator change (FIGURE 27).

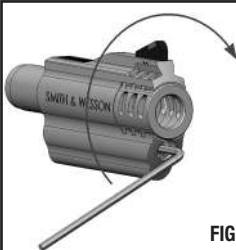

FIGURE 24



FIGURE 25



USE CROSS HOLES FOR HELP IN REMOVAL

FIGURE 26



FIGURE 27

REMOVABLE COMPENSATOR CONTINUED

COMPENSATOR ATTACHMENT INSTRUCTIONS



WARNING: ENSURE THAT YOUR FIREARM IS UNLOADED BEFORE ATTEMPTING ANY ADJUSTMENT OR COMPENSATOR CHANGE. ALWAYS FOLLOW THE RULES OF SAFE GUN HANDLING.

1. Insert the compensator into the front of the barrel shroud (FIGURE 28).



FIGURE 28

2. Rotate the compensator with your fingers either left or right so that the notch is facing down (in the 6 o'clock position) (FIGURE 29).

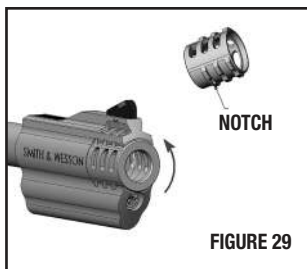

FIGURE 29

3. Insert a 2.5mm hex wrench into the screw under the compensator, (below the muzzle opening). While holding the compensator with your fingers, turn the wrench COUNTERCLOCKWISE until the lock screw stops (2-3 turns). DO NOT OVER-TIGHTEN! (FIGURE 30).

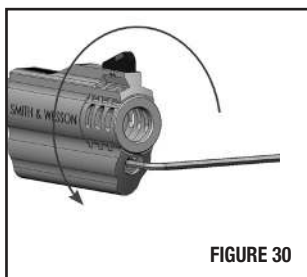

FIGURE 30

CLEANING AND MAINTENANCE



WARNING: ENSURE THAT YOUR FIREARM IS UNLOADED BEFORE BEGINNING TO CLEAN IT. (SEE “INSPECTING YOUR FIREARM” SECTION). ALWAYS FOLLOW THE RULES OF SAFE GUN HANDLING.



WARNING: WEAR SAFETY GLASSES EVERY TIME YOU ASSEMBLE OR DISASSEMBLE YOUR FIREARM AND ATTEMPT CLEANING OR MAINTENANCE.

- Before using your firearm for the first time, it should be cleaned.
- Your firearm was treated at the factory with either a preservative or oil to protect it against corrosion during shipping and storage.
- Preservative and oil should be wiped from the bore, chamber and exposed areas using a clean swab or patch before using the firearm.

CAUTION: Never disassemble your firearm beyond the instructions in the Field Stripping and Inspection sections of this manual.

- Purchase cleaning supplies from your firearms dealer that are specifically designated for your type and caliber of firearm. Many suppliers offer these in kit form for your convenience.
- Follow the instructions provided with your cleaning supplies.

NOTE: A basic firearm cleaning kit should include: a brass bore brush and a cleaning jag of appropriate size for the bore being cleaned, high-quality gun cleaning solvent and gun oil/lubricant, cotton cleaning patches and a cleaning rod that is long enough to push the brush and jag completely through the barrel.

- Remove excessive firing residue from the bore and chamber using a properly fitted brass brush dipped in gun cleaning solvent. Finish the bore cleaning process by running a dry cotton cloth patch through the bore to remove residue and solvent.
- Clean the exterior of the firearm using a non-abrasive cleaning cloth.
- After cleaning, lightly coat the metal parts, internal and external with a high quality gun oil. Refer to the “Lubrication” section in this manual for instructions on lubricating the firearm.
- Whenever your firearm has been exposed to sand, dust, extreme humidity, water or other adverse conditions, it must be cleaned and lubricated.

CLEANING AND MAINTENANCE CONTINUED



WARNING: ALWAYS HAVE ADEQUATE VENTILATION. CLEANING FIREARMS IN POORLY VENTILATED AREAS, DISCHARGING FIREARMS, OR HANDLING AMMUNITION MAY RESULT IN EXPOSURE TO LEAD AND OTHER SUBSTANCES KNOWN TO CAUSE BIRTH DEFECTS, REPRODUCTIVE HARM, AND OTHER SERIOUS PHYSICAL INJURY. WASH HANDS THOROUGHLY AFTER EXPOSURE.

CAUTION: Always follow the instructions provided with your gun cleaner and gun lubricant.

CAUTION: Some cleaners can cause damage to your firearms. You should avoid prolonged solvent immersion and prolonged ultrasonic cleaning of your firearm. Choice of solvent should be restricted to those products specifically developed for firearms maintenance. Damage to a firearm's finish may occur if these cautions are ignored. Ammoniated solvents or other strong alkaline solvents, should not be used on any Smith & Wesson firearm.

- Cleaning is essential to ensure the proper functioning of your firearm.
- Your firearm is a precision instrument. To ensure reliable function it is necessary to follow a routine maintenance procedure. After firing your firearm, be sure to unload it following the procedure outlined in the section entitled "Inspecting Your Firearm" before performing any cleaning or maintenance procedure.
- Remove any gun cleaning solution, oil and fingerprints from the outside surfaces of the firearm. (Finger moisture, if left, could start a corrosion process).



WARNING: NEVER MANIPULATE, ADJUST OR CHANGE ANY OF THE INTERNAL COMPONENTS OF YOUR FIREARM UNLESS SPECIFICALLY DIRECTED TO DO SO IN THIS MANUAL. IMPROPER MANIPULATION OF ANY INTERNAL COMPONENT MAY AFFECT THE SAFETY AND RELIABILITY OF YOUR FIREARM AND MAY CAUSE SERIOUS INJURY OR DEATH.



WARNING: ANY MAINTENANCE OR SERVICE NOT SPECIFIED IN THIS MANUAL MUST BE PERFORMED BY A QUALIFIED GUNSMITH USING GENUINE SMITH & WESSON PARTS. IF YOU DO OTHERWISE, IMPROPER FUNCTIONING OF YOUR FIREARM MAY OCCUR AND SERIOUS INJURY OR DEATH MAY RESULT.

- If your firearm will be used in a cold climate, be sure to use an oil of an appropriate weight so that it will not congeal in cold temperatures, causing the interaction of important parts to be slowed or halted.

CLEANING AND MAINTENANCE CONTINUED

MAINTENANCE BEFORE STORAGE

- When storing, do not encase your firearm in anything that will attract or hold moisture, for example, leather or heavy cloth. Also, do not store guns with a plug inserted in the barrel for this can be a contributing factor to moisture accumulation. If your firearm is to be stored for an extended period, the bore, chambers and internal working mechanism should be oiled with a high quality lubricating oil or preservative intended for firearms. The external working mechanisms and barrel should be coated with an anti-rust oil. Before using your firearm again, be sure to clean it. Every time you clean your firearm, check it for signs of wear. If wear is noted, do not use the firearm. Return it to Smith & Wesson for service or have it checked by a qualified gunsmith.

LIMITED WARRANTY

For Owners Within The United States.

This warranty is granted by Smith & Wesson Inc. This warranty is effective from the date of purchase and applies to the original owner of any firearm. With respect to such firearms, this warranty supercedes any and all other warranties.

Smith & Wesson firearms are warranted to be free from defects in material and workmanship. Any such defects of which Smith & Wesson receives written notice within one year from the date of purchase by the original owner, will be remedied by Smith & Wesson without charge within a reasonable time after such notification and delivery of the firearm as provided below.

In the event of an emergency (repairs needed by law enforcement, an upcoming match or hunting trip), call 1-800-331-0852, ext. 4125 and ask for 911 Priority Repair Service. This allows you to speak with a Smith & Wesson representative. Immediately upon receipt, your firearm will be assigned to a gunsmith. After the work is completed, we will return your Smith & Wesson firearm via overnight delivery.

To submit a warranty claim please see the "Contact and Shipping Information" below for details. In addition to the requested information, please include a copy of the bill of sale in the owner's name, or a copy of the ATF Form 4473 indicating date of purchase. It is always important that the owner comply with all applicable federal, state and local laws and regulations.

Warranty claims should state the model and serial number of the firearm concerned and the description of the difficulty experienced. It is recommended that shipments be insured by the owner, since Smith & Wesson will accept no responsibility for loss or damage in transit. Transportation and insurance charges for return to owner will be paid by Smith & Wesson if the claim is covered by the warranty.

UNDER NO CIRCUMSTANCES SHALL SMITH & WESSON BE RESPONSIBLE FOR INCIDENTAL OR CONSEQUENTIAL DAMAGES WITH RESPECT TO ECONOMIC LOSS, INJURY, DEATH OR PROPERTY DAMAGE, WHETHER AS A RESULT OF BREACH OF THIS WARRANTY, NEGLIGENCE OR OTHERWISE.

Some States do not allow the exclusion or limitation of incidental or consequential damages, so the above limitation or exclusion may not apply to you.

LIMITED WARRANTY CONTINUED

Smith & Wesson will not be responsible for:

- Defects or malfunctions resulting from careless handling, unauthorized adjustments or modifications made or attempted by anyone other than a qualified gunsmith following Smith & Wesson authorized procedures, or failure to follow the disassembly instructions in the Smith & Wesson manual.
- Use of defective or improper ammunition, corrosion, neglect, abuse, ordinary wear and tear, or unreasonable use.
- Criminal misuse, negligence or use under the influence of drugs or alcohol.

Smith & Wesson's Lifetime Service Policy begins after the warranty period has expired. Smith & Wesson will repair, without charge, for the lifetime of the original owner, any Smith & Wesson handgun purchased on or after February 1, 1989, and any M&P series rifle that is found to have a defect in material or workmanship. Eligibility for this Lifetime Service Policy requires returning the printed Product Registration Card within 30 days of purchase or registering the purchase online within 30 days of purchase at www.smith-wesson.com.

The Lifetime Service Policy covers functional defects; it does not include the firearm's finish, grips, magazines or sights.

The Lifetime Service Policy is in addition to and not an extension of the Smith & Wesson Warranty.

This warranty gives you specific legal rights. You may also have other rights that vary from State to State.

NOTE: All liability is excluded in the event that the instructions in the Smith & Wesson manual are not observed.

CONTACT AND SHIPPING INFORMATION

For Owners Within The United States.

NOTE: A Return Merchandise Authorization (**RMA**) is the first step in the process of returning a product in order to receive a repair, replacement or refund. Please contact Smith & Wesson's Customer Service Dept. (via e-mail: qa@smith-wesson.com or by phone at 1-800-331-0852 ext. 4125) to obtain authorization to return your firearm so we can process it quickly and efficiently. The RMA number that is supplied by Smith & Wesson must be displayed on the outside of the returned product's packaging; returns without an RMA number will be routed differently which will result in delayed processing.

The Return Merchandise Authorization (**RMA**) process allows Smith & Wesson an opportunity to try to diagnose and correct a customer's concerns with the product (such as ammunition problems) before it is returned. Accordingly, please contact us before returning your Smith & Wesson firearm.

CONTACT CUSTOMER SERVICE

Tel: 1-800-331-0852 ext. 4125

E-mail: qa@smith-wesson.com

RETURNS - FOR SERVICE

ALL SMITH & WESSON FIREARMS

**Smith & Wesson
2100 Roosevelt Avenue
Springfield, MA 01104**

Should your Smith & Wesson firearm require service, it should be returned to the Smith & Wesson factory.

- Call or e-mail the Customer Service Dept. for authorization and shipping instructions.
- Ensure that the firearm is unloaded.
- Do not attempt to ship a firearm via US Postal Service; only federally licensed dealers may ship a firearm by US Postal Service.
- **DO NOT SHIP ANY AMMUNITION.**

CONTACT AND SHIPPING CONTINUED

- Enclose a letter which includes your full name and address (no P.O. Boxes, please), daytime telephone number, e-mail address, the serial number of the firearm, and details of the problem experienced (stating the brand and type of ammunition used when the problem occurred) or work desired.
- Record the serial number before shipping, in case you wish to check on the repair status of your firearm.
- Please remove all custom parts and accessories, such as stocks, special sights and scopes, or holsters from your firearm before returning.
- Place the firearm in its original case or in a similarly secure container and pack it securely.
- The package must NOT bear any markings which indicate the identity of the contents.
- It is most important that you comply with federal, state, and local laws and regulations. The following guidelines are meant to help, but you must seek assistance from the appropriate authorities if necessary.
- If your firearm must be replaced, it may be necessary to ship the replacement to a dealer rather than directly to you. You will be requested to furnish a signed FFL (Federal Firearms License) from your dealer in such an instance.
- Warranty repair work will begin upon receipt and examination of the firearm. In the case of repairs or work not covered by the warranty, a quotation covering the cost of the work plus round trip transportation charges will be sent to you. Repairs or modification will be scheduled upon receipt of payment.
- A parts list can be obtained by contacting Smith & Wesson Customer Service.



WARNING: YOU MAY PURCHASE ACCESSORIES FOR YOUR SMITH & WESSON FIREARM. YOU MUST HAVE SOME OF THESE PARTS INSTALLED BY A GUNSMITH QUALIFIED TO PERFORM SERVICE ON SMITH & WESSON FIREARMS. YOU MUST NEVER ATTEMPT TO MODIFY YOUR FIREARM OR INSTALL REPLACEMENT PARTS IN YOUR FIREARM. ALWAYS USE A QUALIFIED SMITH & WESSON GUNSMITH EVEN IF THE REPAIR SEEMS TO BE SIMPLE.

CUSTOM SERVICE

- We understand that Smith & Wesson gun owners may want to enhance their guns with custom gunsmithing, refinishing or accessories. Our gunsmiths offer specialized services and exclusive products to enhance your shooting experience.
- Accessories for your Smith & Wesson firearm are available from your local Smith & Wesson Stocking Dealer, or directly from Smith & Wesson.
- Contact the Customer Service Department at 1-800-331-0852, ext. 4125 for information about these services.

When ordering directly from the factory, please provide the following information:

- Model Number
- Dash Number (if applicable)
- Serial Number
- Approximate date of purchase
- Your Complete Return Address
- VISA/Discover/MasterCard Number and Expiration Date
- For Foreign Orders Only, Fax Number or E-mail Address

This handgun is not equipped with a device that fully blocks use by unauthorized users. More than 200,000 firearms like this one are stolen from their owners every year in the United States. In addition, there are more than a thousand suicides each year by younger children and teenagers who get access to firearms. Hundreds more die from accidental discharge. It is likely that many more children sustain serious wounds or inflict such wounds accidentally on others. In order to limit the chance of such misuse, it is imperative that you keep this firearm locked in a secure place and take other steps necessary to limit the possibility of theft or accident. Failure to take reasonable preventative steps may result in innocent lives being lost, and in some circumstances may result in your liability for these deaths.

The certification below is required only for handguns sold in the United States with a barrel length shorter than 3".

Smith & Wesson Inc. hereby certifies average accuracy test results for all new handguns with a barrel shorter than 3" as follows:

7 yards	14 yards	21 yards
1.7"	3.9"	6.3"

This certification is based on tests conducted by Smith & Wesson Inc. using a fixed handgun rest and firing ammunition manufactured by a member of the Shooting Arms and Ammunition Manufacturers Institute (SAAMI) as defined in ANSI/SAAMI Z299.3-1993.

This certification represents actual tests based on several handguns, selected at random. Your particular handgun may have accuracy better than the results stated in this certification.

PORTED BARREL WARNINGS

On Those S&W® Revolvers So-Equipped



WARNING: ALWAYS KEEP YOUR FACE, HANDS, FINGERS, OR ANY OTHER BODY PARTS AWAY FROM THE BARREL/CYLINDER GAP AND BARREL PORTS (INCLUDING PORTS IN COMPENSATORS) DURING FIRING. ALWAYS ENSURE THAT BYSTANDERS ARE AWAY FROM THE BARREL/CYLINDER GAP AND BARREL PORTS DURING FIRING. PARTICLES AND HOT GAS WILL BE FORCED OUT OF THE BARREL/CYLINDER GAP AND BARREL PORTS DURING NORMAL USE. FAILURE TO FOLLOW THIS WARNING WILL CAUSE SERIOUS PERSONAL INJURY AND MAY ALSO RESULT IN DAMAGE TO PROPERTY (CLOTHING, ETC.).

- **DO NOT SHOOT A REVOLVER WITH OR WITHOUT A PORTED BARREL “FROM THE HIP” OR FROM A RETENTION POSITION (WHEN THE FIREARM IS IN CLOSE PROXIMITY TO ANY PART OF THE BODY).**
- **USE CAUTION WHEN SHOOTING TO AVOID CONTACT WITH ANY SURROUNDING OBJECTS THAT COULD BE DAMAGED BY THE PARTICLES AND HOT GAS FORCED FROM THE BARREL/CYLINDER GAP AND BARREL/COMPENSATOR PORTS DURING FIRING.**

Showing location of exhaust ports
in compensator of a typical
S&W® revolver so-equipped.

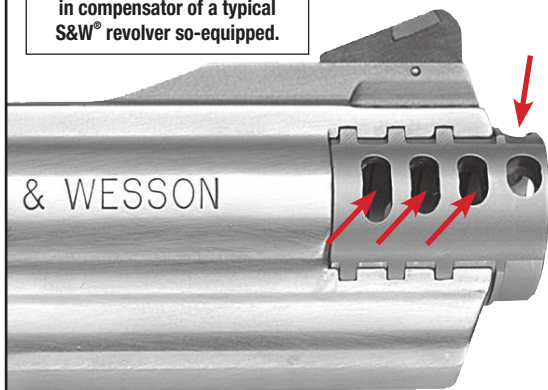

FIGURE 1p

PATENT INFORMATION

• This product may be covered by one or more patents.
Visit www.smith-wesson.com for virtual patent information.

INTERNATIONAL WARRANTY CENTERS

For Owners Outside The United States

NOTE: Addresses and contact information for International Warranty Centers is available on the Smith & Wesson website at www.smith-wesson.com or by calling Customer Service toll-free at 1-800-331-0852 ext 4125.

BATTERY WARNINGS



WARNING: IF A BATTERY OPERATED ACCESSORY OR ATTACHMENT (I.E. LASER, OPTICAL SIGHT OR FLASHLIGHT, ETC.) IS SUPPLIED OR USED WITH THIS FIREARM, THE FOLLOWING WARNINGS AND INSTRUCTIONS MUST BE ADHERED TO.



WARNING: KEEP BATTERIES AWAY FROM CHILDREN. THERE IS A CHEMICAL BURN HAZARD ASSOCIATED WITH BATTERIES.



WARNING: IF A NEW OR USED LITHIUM BUTTON/ COIN CELL BATTERY IS SWALLOWED OR ENTERS THE BODY, IT CAN CAUSE SEVERE INTERNAL BURNS AND CAN LEAD TO DEATH IN AS LITTLE AS 2 HOURS. ALWAYS COMPLETELY SECURE THE BATTERY COMPARTMENT. IF THE BATTERY COMPARTMENT DOES NOT CLOSE SECURELY, STOP USING THE PRODUCT, REMOVE THE BATTERIES, AND KEEP IT AWAY FROM CHILDREN. IF YOU THINK BATTERIES MIGHT HAVE BEEN SWALLOWED OR PLACED INSIDE ANY PART OF THE BODY, SEEK IMMEDIATE MEDICAL ATTENTION.

- When used correctly, batteries provide a safe and dependable source of portable power. However, misuse or abuse may result in leakage, fire, or explosion.
- Batteries can explode or leak and cause burns if installed backwards, disassembled, charged, or exposed to water, fire or high temperature.
- Always take care to install your batteries correctly observing the “+” and “-” marks on the battery and the device.
- Always replace the whole set of batteries at one time, taking care not to mix old and new batteries, or batteries of different types.
- Store unused batteries in their original packaging and away from metal objects that may short-circuit them.
- Remove discharged batteries from equipment promptly to avoid possible damage from leakage.
- Never dispose of batteries in fire. (Failure to observe this precaution may result in an explosion.)
- The batteries are supplied in a charged state and are not designed for recharging. Recharging may cause leakage, fire, or explosion.
- The batteries should be disposed of properly, including keeping them away from children.
- Dispose of used batteries immediately. Even used batteries may cause injury.

AirLite®
Airweight®
Bodyguard®
Carry Comp®
Chiefs Special®
Governor®

LadySmith®

Magnum®
Mountain Gun®
Performance Center®
S&W®
Smith & Wesson®



3012881

SMITH & WESSON
2100 ROOSEVELT AVENUE • SPRINGFIELD, MA 01104
WWW.SMITH-WESSON.COM